

Sorensen

SGL Series
DC Power Supplies
Operation Manual

SORENSEN Power Supplies
Elgar Electronics Corporation
9250 Brown Deer Road
San Diego, CA 92121-2294
1-800-73ELGAR (1-800-733-5427)
Tel: (858) 450-0085
Fax: (858) 458-0267
Email: sales@elgar.com
www.elgar.com

©2004 by Elgar Electronics Corporation

This document contains information proprietary to Elgar Electronics Corporation. The information contained herein is not to be duplicated or transferred in any manner without prior written permission from Elgar Electronics Corporation.

ELGAR FIVE-YEAR WARRANTY

Sorensen products are warranted by Elgar Electronics Corporation to be free from defects in material and workmanship. This warranty is effective for five years from the date of shipment of the product to the original purchaser. Liability of Elgar under this warranty shall exist provided that:

- the Buyer exposes the product to normal use and service and provides normal maintenance on the product;
- Elgar is promptly notified of defects by the Buyer and that notification occurs within the warranty period;
- the Buyer receives a Return Material Authorization (RMA) number from Elgar's Repair Department prior to the return of the product to Elgar for repair, phone 800-73ELGAR (800-733-5427);
- the Buyer returns the defective product in the original, or equivalent, shipping container;
- if, upon examination of such product by Elgar it is disclosed that, in fact, a defect in materials and/or workmanship does exist, that the defect in the product was not caused by improper conditions, misuse, or negligence; and,
- that QA seal and nameplates have not been altered or removed and the equipment has not been repaired or modified by anyone other than Elgar authorized personnel. After a product is evaluated and a consultation performed with the Buyer, if no failure exists, then the product may be subject to an evaluation fee.

This warranty is exclusive and in lieu of all other warranties, expressed or implied, including, but not limited to, implied warranties of merchantability and fitness of the product to a particular purpose. Elgar, its agents, or representatives shall in no circumstance be liable for any direct, indirect, special, penal, or consequential loss or damage of any nature resulting from the malfunction of the product. Remedies under this warranty are expressly limited to repair or replacement of the product.

CONDITIONS OF WARRANTY

- To return a defective product, contact an Elgar representative or the Elgar factory for an RMA number. Unauthorized returns will not be accepted and will be returned at the shipper's expense.
- For Sorensen products found to be defective within thirty days of receipt by the original purchaser, Elgar will absorb all ground freight charges for the repair. Products found defective within the warranty period, but beyond the initial thirty-day period, should be returned prepaid to Elgar for repair. Elgar will repair the unit and return it by ground freight pre-paid.
- Normal warranty service is performed at Elgar during the weekday hours of 7:00 am to 4:00 pm Pacific time. Warranty repair work requested to be accomplished outside of normal working hours will be subject to Elgar non-warranty service rates.
- Warranty field service is available on an emergency basis. Travel expenses (travel time, per diem expense, and related air fare) are the responsibility of the Buyer. A Buyer purchase order is required by Elgar prior to scheduling.
- A returned product found, upon inspection by Elgar, to be in specification is subject to an inspection fee and applicable freight charges.
- Equipment purchased in the United States carries only a United States warranty for which repair must be accomplished at the Elgar factory.

Sorensen

Committed to Quality...Striving for Excellence

SAFETY NOTICE

Before applying power to the system, verify that the SG Series supply is configured properly for the user's particular application.



WARNING!

HAZARDOUS VOLTAGES IN EXCESS OF 280 VRMS, 600V PEAK MAY BE PRESENT WHEN COVERS ARE REMOVED. QUALIFIED PERSONNEL MUST USE EXTREME CAUTION WHEN SERVICING THIS EQUIPMENT. CIRCUIT BOARDS, TEST POINTS, AND OUTPUT VOLTAGES MAY BE FLOATING ABOVE (BELOW) CHASSIS GROUND.

Installation and service must be performed by qualified personnel who are aware of dealing with attendant hazards. This includes such simple tasks as fuse verification.

Ensure that the AC power line ground is connected properly to the SGI Series unit input connector or chassis. Similarly, other power ground lines including those to application and maintenance equipment must be grounded properly for both personnel and equipment safety.

Always ensure that facility AC input power is de-energized prior to connecting or disconnecting the input/output power cables.



During normal operation, the operator does not have access to hazardous voltages within the chassis. However, depending on the user's application configuration, HIGH VOLTAGES HAZARDOUS TO HUMAN SAFETY may be generated normally on the output terminals. Ensure that the output power lines are labeled properly as to the safety hazards and that any inadvertent contact with hazardous voltages is eliminated. To guard against risk of electrical shock during open cover checks, do not touch any portion of the electrical circuits. Even when the power is off, capacitors can retain an electrical charge. Use safety glasses during open cover checks to avoid personal injury by any sudden failure of a component.

Due to filtering, the unit has high leakage current to the chassis. Therefore, it is essential to operate this unit with a safety ground.

Some circuits are live even with the front panel switch turned off. Service, fuse verification, and connection of wiring to the chassis must be accomplished at least five minutes after power has been removed via external means; all circuits and/or terminals to be touched must be safety grounded to the chassis.

After the unit has been operating for some time, the metal near the rear of the unit may be hot enough to cause injury. Let the unit cool before handling.

Qualified service personnel need to be aware that some heat sinks are not at ground, but at high potential.

These operating instructions form an integral part of the equipment and must be available to the operating personnel at all times. All the safety instructions and advice notes are to be followed.

Neither Elgar Electronics Corporation, San Diego, California, USA, nor any of the subsidiary sales organizations can accept any responsibility for personal, material or consequential injury, loss or damage that results from improper use of the equipment and accessories.

SAFETY SYMBOLS



CAUTION
Risk of Electrical Shock



CAUTION
Refer to Accompanying Documents



Off (Supply)



Direct Current (DC)



Standby (Supply)



Alternating Current (AC)



On (Supply)



Three-Phase Alternating Current



Protective Conductor Terminal



Earth (Ground) Terminal



Fuse



Chassis Ground

FCC NOTICE

This equipment has been tested and found to comply with the limits for a Class A digital device, pursuant to part 15 of the FCC Rules. These limits are designed to provide reasonable protection against harmful interference when the equipment is operated in a commercial environment. This equipment generates, uses, and can radiate radio frequency energy and, if not installed and used in accordance with the instruction manual, may cause harmful interference to radio communications. Operation of this equipment in a residential area is likely to cause harmful interference in which case the user will be required to correct the interference at his own expense.

ABOUT THIS MANUAL

This manual has been written expressly for the Sorensen SGI Series of power supplies that have been designed and certified to meet the Low Voltage and Electromagnetic Compatibility Directive Requirements of the European Community.

Since the Low Voltage Directive is to ensure the safety of the equipment operator, universal graphic symbols have been used both on the unit itself and in this manual to warn the operator of potentially hazardous situations (see Safety Symbols on page iv).

CONTENTS

| | |
|---|-----|
| SECTION 1 OVERVIEW..... | 1-1 |
| 1.1 General Description | 1-1 |
| 1.2 Technical Specifications | 1-1 |
| 1.2.1 Environmental Characteristics | 1-1 |
| 1.2.2 Electrical Characteristics | 1-2 |
| 1.2.3 SGI Series Voltage and Current Specifications | 1-4 |
| 1.2.4 Physical Characteristics..... | 1-4 |
| SECTION 2 INSTALLATION..... | 2-1 |
| 2.1 Inspection | 2-1 |
| 2.2 Contents of Shipment | 2-1 |
| 2.3 Input/Output Connections | 2-2 |
| 2.4 Location and Mounting | 2-2 |
| 2.4.1 6U Chassis Removal from Rack..... | 2-3 |
| 2.5 Wire Size | 2-4 |
| 2.6 Wire Gauge Selection..... | 2-5 |
| 2.7 Load Considerations..... | 2-7 |
| 2.7.1 Inductive Loads..... | 2-7 |
| 2.8 Outline Drawings | 2-7 |
| SECTION 3 OPERATION..... | 3-1 |
| 3.1 Introduction..... | 3-1 |
| 3.2 Controls and Indicators..... | 3-1 |
| 3.2.1 Front Panel | 3-1 |
| 3.2.2 Rear Panel..... | 3-3 |

| | | |
|--------|---|------|
| 3.3 | Initial Start-up and Displays | 3-4 |
| 3.4 | Display Elements | 3-4 |
| 3.5 | Navigation | 3-5 |
| 3.6 | Editing | 3-6 |
| 3.6.1 | Aborting an Edit..... | 3-7 |
| 3.7 | Menu Map | 3-8 |
| 3.7.1 | Home Menu..... | 3-8 |
| 3.7.2 | Default Programming Menu | 3-8 |
| 3.7.3 | Navigating from Home Menu Page 1 | 3-8 |
| 3.7.4 | Navigating from Home Menu Page 2 | 3-8 |
| 3.7.5 | Navigating from Home Menu Page 3 | 3-9 |
| 3.7.6 | Sequence Menu | 3-9 |
| 3.7.7 | Sequence Programming Operation..... | 3-9 |
| 3.7.8 | Constant Power Setup Menu | 3-10 |
| 3.7.9 | Remote Example Screens | 3-10 |
| 3.7.10 | Warning Screens..... | 3-10 |
| 3.7.11 | Other Screens | 3-10 |
| 3.8 | Functions..... | 3-11 |
| 3.8.1 | Voltage, Current, and Overvoltage Protection Programming..... | 3-11 |
| 3.8.2 | Save | 3-11 |
| 3.8.3 | Recall | 3-12 |
| 3.8.4 | Sequencing | 3-12 |
| 3.8.5 | Power Mode | 3-20 |
| 3.8.6 | Home Timeout..... | 3-20 |
| 3.8.7 | Display Brightness | 3-20 |
| 3.8.8 | Lock Key | 3-21 |
| 3.8.9 | Language | 3-21 |
| 3.8.10 | Info | 3-21 |
| 3.8.11 | Remote..... | 3-21 |
| 3.8.12 | System | 3-22 |
| 3.8.13 | Warning Screens..... | 3-22 |
| 3.9 | Basic Operation and Output Verification | 3-22 |
| 3.9.1 | Initial Setup | 3-23 |
| 3.9.2 | Default Programming Menu | 3-23 |
| 3.9.3 | Remote Analog Control..... | 3-25 |
| 3.10 | Remote Current Programming | 3-29 |
| 3.11 | Remote Voltage Programming..... | 3-30 |

| | | |
|---|---|------------|
| 3.12 | Remote Sensing | 3-31 |
| 3.13 | Remote Output On/Off Control | 3-33 |
| 3.14 | Remote Overvoltage Setpoint..... | 3-34 |
| 3.15 | Remote Shutdown (S/D)..... | 3-35 |
| 3.16 | Master/Slave Operation | 3-35 |
| 3.16.1 | Parallel Operation | 3-35 |
| 3.16.2 | Series Operation..... | 3-36 |
| SECTION 4 VERIFICATION AND CALIBRATION | | 4-1 |
| 4.1 | Introduction..... | 4-1 |
| 4.1.1 | Verification and Calibration Cycle..... | 4-1 |
| 4.1.2 | Preparation | 4-1 |
| 4.2 | Standard Verification and Calibration Procedure..... | 4-2 |
| 4.2.1 | Current Mode..... | 4-2 |
| 4.2.2 | Voltage Mode..... | 4-3 |
| 4.2.3 | Resistor Programming Current Sources..... | 4-4 |
| 4.3 | Isolated Analog (Option) Verification and Calibration Procedure | 4-5 |
| 4.3.1 | Current Mode..... | 4-5 |
| 4.3.2 | Voltage Mode..... | 4-5 |
| SECTION 5 MAINTENANCE..... | | 5-1 |
| 5.1 | Introduction..... | 5-1 |
| 5.2 | Preventive Maintenance | 5-1 |
| 5.3 | Fuses..... | 5-3 |
| LIST OF TABLES | | |
| Table 2–1 | 5kW to 15kW and 20kW to 30kW Series Input/Output Connectors | 2-3 |
| Table 2–2 | Input Connections..... | 2-3 |
| Table 2–3 | Output Connections..... | 2-4 |
| Table 2–4 | Minimum Wire Size..... | 2-5 |
| Table 2–5 | Recommended Wire Gauge Selection Guide..... | 2-6 |
| Table 2–6 | Maximum AC Current Ratings..... | 2-6 |
| Table 2–7 | Recommended Lugs | 2-6 |
| Table 2–8 | Recommended Sense Connector Tools..... | 2-7 |
| Table 3–1 | Analog Control Connector (J1), Designations and Functions..... | 3-28 |
| Table 5–1 | Recommended Annual Inspection..... | 5-2 |
| Table 5–2 | Fuse Values..... | 5-3 |

LIST OF FIGURES

| | |
|--|------|
| Figure 2–1 SGI Series Outline Drawing, 3U Models 5kW to 15kW | 2-8 |
| Figure 2–2 SGI Series Outline Drawing, 6U Models, 20kW to 30kW | 2-9 |
| Figure 3–1 Front Panel Controls and Indicators | 3-2 |
| Figure 3–2 Rear Panel Connectors (3U model shown) | 3-3 |
| Figure 3–3 Burn-in Sequence Example | 3-17 |
| Figure 3–4 Constant Power Example | 3-20 |
| Figure 3–5. Analog Control Connector (J1) Pin-out..... | 3-26 |
| Figure 3–6 Remote Current Programming Using Resistance..... | 3-29 |
| Figure 3–7 Remote Current Programming Using 0-5 VDC or 0-10 VDC Voltage Source | 3-30 |
| Figure 3–8 Remote Voltage Programming Using Resistance | 3-30 |
| Figure 3–9 Remote Voltage Programming Using 0-5 VDC or 0-10 VDC Voltage Source | 3-31 |
| Figure 3–10 Remote Sensing Operation at the Load | 3-32 |
| Figure 3–11 Remote On/Off Control by Contact Closure | 3-33 |
| Figure 3–12 Remote On/Off Using Isolated AC or DC Voltage Source..... | 3-33 |
| Figure 3–13 Remote On/Off Using Isolated TTL/CMOS Voltage Supply | 3-34 |
| Figure 3–14 Remote Overvoltage Set Using DC Voltage Source | 3-34 |
| Figure 3–15 Remote Shutdown Using DC Voltage Source | 3-35 |
| Figure 3–16 Master/Slave Connection..... | 3-35 |
| Figure 4–1 Precision Current Shunt..... | 4-2 |
| Figure 4–2 Potentiometer Locations | 4-7 |

SECTION 1 OVERVIEW

1.1 General Description

The Sorensen SG Series power supplies are general-purpose power supplies designed specifically for laboratory test and systems applications requiring variable DC sources with good ripple and regulation characteristics. These power supplies are constant current/constant voltage supplies with an automatic crossover feature.

A variety of user interfaces are available, ranging from manual front-panel control and standard non-isolated remote analog control, to optional GPIB or isolated remote analog control.

1.2 Technical Specifications

The following sections provide environmental, electrical, and physical characteristics for the SGI Series power supplies.

1.2.1 Environmental Characteristics

Note: The SGI Series power supplies are intended for indoor use only.

| Parameter | Specification |
|-------------------------|---|
| Temperature Coefficient | 0.02%/°C of maximum output voltage rating for voltage set point. 0.03%/°C of maximum output current rating for current set point. |
| Ambient Temperature | |
| Operating | 0 to 50°C |
| Storage | -25° to 65°C |
| Cooling | Internal fans. Units may be stacked without clearance. |
| Humidity | 0 to 90% at 40°C, derate to 50% at 25°C (non-condensing) |
| Altitude | Operating full power available up to 5,000 feet (1,524m), derate 10% of full power for every 1,000 feet higher non-operating to 40,000 feet (12,192m) |
| Agency Approvals | CE Mark to EN61010 and EN61326 UL recognized to UL1012 |

1.2.2 Electrical Characteristics

| Parameter | Specification |
|----------------------------|--|
| Input Power | |
| Voltage (Standard) | 208/220 VAC \pm 10% (tested to 187-242 VAC) |
| Voltage (Options) | 380/400 VAC \pm 10% (tested to 342-440 VAC) 440/480 VAC \pm 10% (tested to 396-528 VAC) |
| Frequency | 47 to 63 Hz |
| Phases | 3-phase, 3-wire plus ground. Not phase rotation sensitive. Neutral not used. |
| Front Panel Meter Accuracy | |
| Voltage | \pm 0.5% of full-scale + 1 digit |
| Current | \pm 0.5% of full-scale + 1 digit |
| Load Regulation | (Specified at no load to full load, nominal AC input) |
| Voltage | 0.02% of maximum output voltage |
| Current | 0.1% of maximum output current |
| Line Regulation | (Specified \pm 10% of nominal AC input, constant load) |
| Voltage | 0.01% of maximum output voltage |
| Current | 0.05% of maximum output current |
| Transient Response | A 50% step load will recover to within 0.75% of original value within 1 ms. |
| Down Programming | With no load the output will program from 100 to 10% in less than 1.5 seconds |
| Stability | \pm 0.05% of set point after 8-hr. warm-up at fixed line, load, and temperature using remote sense |
| Remote Control/Monitor | On/Off control via contact closure, 6-120 VDC or 12-240 VAC, and TTL or CMOS switch, output voltage and current monitor, OVP limit set, summary fault status |
| Power Factor | >0.9 typical for 208/220VAC input >0.78 typical for 380/400VAC input >0.7 typical for 440/480VAC input |
| Efficiency | 87% typical at full load, nominal line |
| Remote Programming | |
| Accuracy | |
| Constant Voltage | \pm 0.25% of full-scale output (Vp5 input) |

| Parameter | Specification |
|---|---|
| Constant Current | ±0.8% of full-scale output |
| Overvoltage Protection (OVP) | ±1% of full-scale output |
| Resistive | |
| Constant Voltage (0-100%) | 0–5 kΩ |
| Constant Current (0-100%) | 0–5 kΩ |
| Voltage | |
| Constant Voltage (0-100%) | 0–5 VDC or 0–10 VDC |
| Constant Current (0-100%) | 0–5 VDC or 0–10 VDC |
| Overvoltage Protection (OVP) (0-110%) | 0–5.5 VDC |
| Remote Sensing | Terminals are provided to sense output voltage at point of load. Maximum line drop 5% of rated voltage per line for 60-100V models, 2% of rated voltage per line for models 160V and greater. |
| ISOLATED ANALOG CONTROL (OPTION) | |
| Input to Output Isolation | 500 V Compliant with maximum terminal float voltage. Recommended operation under SELV normal conditions. |

1.2.3 SGI Series Voltage and Current Specifications

| Voltage | Amperage | | | | | | Ripple* RMS | Noise* P-P |
|---------|----------|--------|--------|--------|--------|--------|----------------|---------------|
| | 5 kW | 10 kW | 15 kW | 20 kW | 25 kW | 30 kW | | |
| 0-60V | 0-83A | 0-167A | 0-250A | 0-333A | 0-417A | 0-500A | 20 mV | 75 mV |
| 0-80V | 0-63A | 0-125A | 0-188A | 0-250A | 0-313A | 0-375A | 20 mV | 100 mV |
| 0-100V | 0-50A | 0-100A | 0-150A | 0-200A | 0-250A | 0-300A | 20 mV | 100 mV |
| 0-160V | 0-31A | 0-63A | 0-94A | 0-125A | 0-156A | 0-188A | 25 mV | 150 mV |
| 0-200V | 0-25A | 0-50A | 0-75A | 0-100A | 0-125A | 0-150A | 25 mV | 175 mV |
| 0-250V | 0-20A | 0-40A | 0-60A | 0-80A | 0-100A | 0-120A | 30 mV | 200 mV |
| 0-330V | 0-15A | 0-30A | 0-45A | 0-61A | 0-76A | 0-91A | 30 mV | 200 mV |
| 0-400V | 0-12A | 0-25A | 0-38A | 0-50A | 0-63A | 0-75A | 30 mV | 300 mV |
| 0-600V | 0-8A | 0-17A | 0-25A | 0-33A | 0-42A | 0-50A | 40 mV | 350 mV |

* Ripple and noise specified at full load, nominal AC input

1.2.4 Physical Characteristics

| Dimension | 3U Models | 6U Models |
|-----------|------------------------|-------------------------|
| Width | 19.00 in (48.3 cm) | 19.00 in (48.3 cm) |
| Depth | 25.12 in (63.8 cm) | 25.12 in (63.8 cm) |
| Height | 5.25 in (13.3 cm) | 10.5 in (26.7 cm) |
| Weight | 80 lbs (36 kg) maximum | 160 lbs (73 kg) maximum |

Note: Specifications are subject to change without notice.

SECTION 2 INSTALLATION

2.1 Inspection

Inspect the shipping carton for possible damage before unpacking the unit. Carefully unpack the equipment. Save all packing materials until inspection is complete. Verify that all items listed on the packing slips have been received. Visually inspect all exterior surfaces for broken knobs, connectors, or meters. Inspect for dented or damaged exterior surfaces. External damage may be an indication of internal damage. If any damage is evident, immediately contact the carrier that delivered the unit and submit a damage report. Failure to do so could invalidate future claims. Direct repair issues to Elgar Customer Service at 1-800-73ELGAR (1-800-733-5427).

2.2 Contents of Shipment

Depending on the model, configuration, and options available for your SGI Series power supply, the ship kit may include additional parts and accessories. At a minimum, the ship kit that accompanies your SGI Series power supply includes the following items:

- *SGI Series DC Power Supplies Operation Manual* (Elgar Document No. M550129-01)
- Sense mating connector (Molex P/N 39-01-4031) with loose contacts (Molex P/N 39-00-0182)
- J1 mating connector (Cinch P/N DB25P or equivalent) normally shipped attached to rear panel J1
- Back shell for J1 (DB25) mating connector (Cinch P/N DCH-B-001 or equivalent)
- Screw, lock washer, and nut for AC input and DC output connections:
5–15 kW: ¼-20UNC-2B x ½", 4 ea AC input only
20–30 kW: ¾-16UNC-2B x 7/8", 6 ea
- Black screw, 10-32UNC-2B x ½", front panel rack fastener:
5–15 kW: 4 ea
20–30 kW: 8 ea

If any of these parts are missing, please contact Elgar Customer Service at 1-800-73ELGAR (1-800-733-5427).

2.3 Input/Output Connections



WARNING!
High voltage present! Risk of electrical shock. Do not remove cover. Refer to qualified service personnel.

Table 2–1 lists all external connections for the SGI Series models. Table 2–2 and Table 2–3 provide input and output connection descriptions by power supply type.

For permanently connected equipment, a readily accessible disconnect device shall be incorporated in the fixed wiring. For pluggable equipment, the socket outlet shall be installed near the equipment and shall be easily accessible.

Take precautions to ensure that the concentration of ozone is limited to a safe value. The recommended long-term exposure limit for ozone is 0.1 PPM (0.2 mg/m³).



CAUTION!
For proper connection to the mains, a 100–amp circuit breaker or fuse for 3U units and a 200–amp circuit breaker or fuse for 6U units is required.



WARNING!
Under no condition should the negative output terminal exceed 150V to earth ground.

2.4 Location and Mounting



WARNING!
To reduce the risk of fire or electrical shock, install the SGI Series unit in a temperature and humidity controlled indoor area, free of conductive contaminants.



CAUTION!
The unit should be provided with proper ventilation. The rear and both sides of the unit should be free of obstructions. To ensure proper airflow, a minimum 4" clearance from the rear air outlet is required. The unit should not be installed in a raised ambient temperature greater than 50°C.



CAUTION!
This unit is intended for installation in a protected environment. No user serviceable parts inside. Service to be performed by qualified personnel only.

The SGI Series models are designed to be mounted in a standard 19-inch equipment rack. If additional instrumentation is mounted in the rack, no additional clearance is required between the SGI series and other power supplies or instruments.

1. Support the unit using rack mount slides or appropriate L brackets (suggested parts are listed below).

Rack Mount Slide Kit:

5–15kW units Elgar P/N K550212-01
20–30kW units Elgar P/N K550213-01

2. Secure the unit in place using the screws provided.

2.4.1 6U Chassis Removal from Rack

The slides have a Front Disconnect Feature and lock at full extension.

To return chassis back into rack from locked full extension, depress the flat steel spring inward (located on the slides) and push chassis back.

To disconnect and remove chassis from rack, depress the flat steel spring inward (located on the slides) and pull chassis forward.



WARNING!

The 6U SGI Series unit weighs up to 160 lbs (73kg) depending on the model. A minimum three-person lift is required!

When the chassis is at full extension, the flat springs are located approximately one (1) inch behind the front EIA RETMA rails. Access the springs with a flat blade screwdriver or similar device, to release from full-extension lock-out or to remove the chassis from the rack.

The slides can be mounted to the chassis with this spring oriented on the top or the bottom of the slide.

Table 2–1 provides details of the SGI Series input and output connectors and their functions.

| Connector | Function | Connects To |
|--|--|---|
| FL1 – AC FL1 – AC FL1 – AC Chassis - GND | Prime AC Power Input See Table 2–2. Not phase rotation sensitive. Neutral not used. | 208/220 VAC (Std) 380/400 VAC (Option) 440/480 VAC (Option) 47-63 Hz |
| Pos. Threaded Stud Neg. Threaded Stud Pos. Bus Bar Neg. Bus Bar | Output Power: 3U models (see Table 2–3) 6U models (see Table 2–3) | User load(s) |
| ANALOG CONTROL Connector (J1) | Control Interface | See Table 3–1 for description |
| Sense Connector | Used for remote sense | Refer to Section 3.12 |
| Parallel In-Out | Used for parallel operation | Refer to Section 3.16 |

Table 2–1 5kW to 15kW and 20kW to 30kW Series Input/Output Connectors

| Power Supply Type | Connection Description |
|-------------------|--------------------------------------|
| 5 kW to 15 kW | Bus Bar with holes for 1/4"–20 bolts |
| 20 kW to 30 kW | Bus Bar with holes for 3/8"–16 bolts |

Table 2–2 Input Connections

| Power Supply Type | Connection Description |
|---------------------------|-----------------------------------|
| 5 kW to 15 kW $\geq 60V$ | 3/8" Threaded Studs |
| 20 kW to 30 kW $\geq 60V$ | Bus Bar with holes for 3/8" bolts |

Table 2–3 Output Connections

Note: Failure to observe the maximum torque specification indicated in the housing will void the warranty on the SGI Series unit.

2.5 Wire Size

Care must be taken to properly size all conductors for the input and output of the power supply. The tables below will assist in determining the appropriate wire size for both the input and output connections Table 2–4 below gives *minimum* recommended wire size. This table is derived from the National Electrical Code; it is for reference only. Local laws and conditions may have different requirements. Note that these recommendations are for copper wire only. For higher ratings, wires can be paralleled; refer to the National Electrical Code.

| Size | Temperature Rating of Copper Conductor | | | |
|------------|--|--|--------------|---|
| | 60°C | 75°C | 85°C | 90°C |
| AWG MCM | Types: RUW, T, TW, UF | Types: FEPW, RHW, RH, RUH, THW, THWN, XHHW, USE, ZW | Types: V, MI | Types: TA, TBS, SA, AVB, SIS, FEP, FEPB, RHH, THHN, XHHW |
| | Current Rating | | | |
| 14 | 20 | 20 | 25 | 25 |
| 12 | 25 | 25 | 30 | 30 |
| 10 | 30 | 35 | 40 | 40 |
| 8 | 40 | 50 | 55 | 55 |
| 6 | 55 | 65 | 70 | 75 |
| 4 | 70 | 85 | 95 | 95 |
| 3 | 85 | 100 | 110 | 110 |
| 2 | 95 | 115 | 125 | 130 |
| 1 | 110 | 130 | 145 | 150 |
| 0 | 125 | 150 | 165 | 170 |
| 00 | 145 | 175 | 190 | 195 |

| Size | Temperature Rating of Copper Conductor | | | |
|------------|--|--|--------------|---|
| | 60°C | 75°C | 85°C | 90°C |
| AWG MCM | Types: RUW, T, TW, UF | Types: FEPW, RHW, RH, RUH, THW, THWN, XHHW, USE, ZW | Types: V, MI | Types: TA, TBS, SA, AVB, SIS, FEP, FEPB, RHH, THHN, XHHW |
| | Current Rating | | | |
| 000 | 165 | 200 | 215 | 225 |
| 0000 | 195 | 230 | 250 | 260 |

Table 2–4 Minimum Wire Size

2.6 Wire Gauge Selection

The following guidelines assist in determining the optimum cable specification for your power applications. The same engineering rules apply whether going into or out of an electrical device. Thus, this guide applies equally to the input cable and output cable for this Sorensen instrument and application loads.

Power cables must be able to safely carry maximum load current without overheating or causing insulation destruction. It is important to everyday performance to minimize IR (voltage drop) loss within the cable. These losses have a direct effect on the quality of power delivered to and from instruments and corresponding loads.

When specifying wire gauge, consider the operating temperature. Wire gauge current capability and insulation performance drops with the increased temperature developed within a cable bundle and with increased environmental temperature. Thus, short cables with generously derated gauge and insulation properties are recommended for power source applications.

Avoid using published commercial utility wiring codes. These codes are designed for the internal wiring of homes and buildings and accommodate the safety factors of wiring loss, heat, breakdown insulation, aging, etc. However, these codes consider that up to 5% voltage drop is acceptable.

Such a loss directly detracts from the quality performance specifications of this Sorensen instrument. Frequently, these codes do not consider bundles of wire within a cable arrangement.

In high performance applications, as in motor start-up and associated inrush/ transient currents, additional consideration is required. The cable wire gauge must consider peak voltages and currents, which may be up to ten times the average values. An underrated wire gauge adds losses, which alter the inrush characteristics of the application and thus the expected performance.

Table 2–5 identifies popular ratings for DC power source cable wire gauges.

| Column 1 | Column 2 | Column 3 | Column 4 |
|------------|-------------------|-------------------------|--|
| Size (AWG) | Amperes (Maximum) | Ohms/100 Feet (One Way) | IR Drop/100 Feet (Column 2 x Column 3) |
| 14 | 15 | 0.257 | 3.85 |
| 12 | 20 | 0.162 | 3.24 |
| 10 | 30 | 0.102 | 3.06 |
| 8 | 40 | 0.064 | 2.56 |
| 6 | 55 | 0.043 | 2.36 |
| 4 | 70 | 0.025 | 1.75 |
| 2 | 95 | 0.015 | 1.42 |
| 1/0 | 125 | 0.010 | 1.25 |
| 3/0 | 165 | 0.006 | 1.04 |

Table 2–5 Recommended Wire Gauge Selection Guide

Refer to Table 2–6 for AC input current requirements and Section 1.2.3 for output current requirements.

| Input V | Input Line Current | | | | | | Unit of Measure |
|------------|--------------------|-------|-------|-------|-------|------|-------------------|
| | 5 kW | 10 kW | 15 kW | 20 kW | 25 kW | 30kW | |
| 208/220VAC | 21 | 41 | 62 | 83 | 103 | 124 | Amps AC per phase |
| 380/400VAC | 14 | 27 | 40 | 54 | 67 | 80 | |
| 440/480VAC | 13 | 26 | 39 | 52 | 65 | 78 | |

Table 2–6 Maximum AC Current Ratings

Refer to Table 2–7 for input/output lug recommendations.

| Lug Manufacturer | 3U Models Input/Output | 6U Models Input/Output |
|------------------|---------------------------|----------------------------|
| Panduit | “PN” Series or equivalent | “LCA” Series or equivalent |

Table 2–7 Recommended Lugs

The recommended tools for installation and extraction of the sense connector are listed below in Table 2–8.

| Tool | Manufacturer | Manufacturer P/N |
|-------------------|---------------------|-------------------------|
| Crimping Device | Molex | 11-01-0197 |
| Extracting Device | Molex | 11-03-0044 |

Table 2–8 Recommended Sense Connector Tools

2.7 Load Considerations

2.7.1 Inductive Loads

To prevent damage to the power supply from inductive kickback, connect a diode (rated at greater than the supply's output voltage and current) across the output. Connect the cathode to the positive output and the anode to return. Where positive load transients such as back EMF from a motor may occur, a second diode in series with the output is recommended to protect the power supply.

2.8 Outline Drawings

Figure 2–1 and Figure 2–2, next, show the outlines and overall dimensions of the 3U and 6U models of the SGI Series product line.

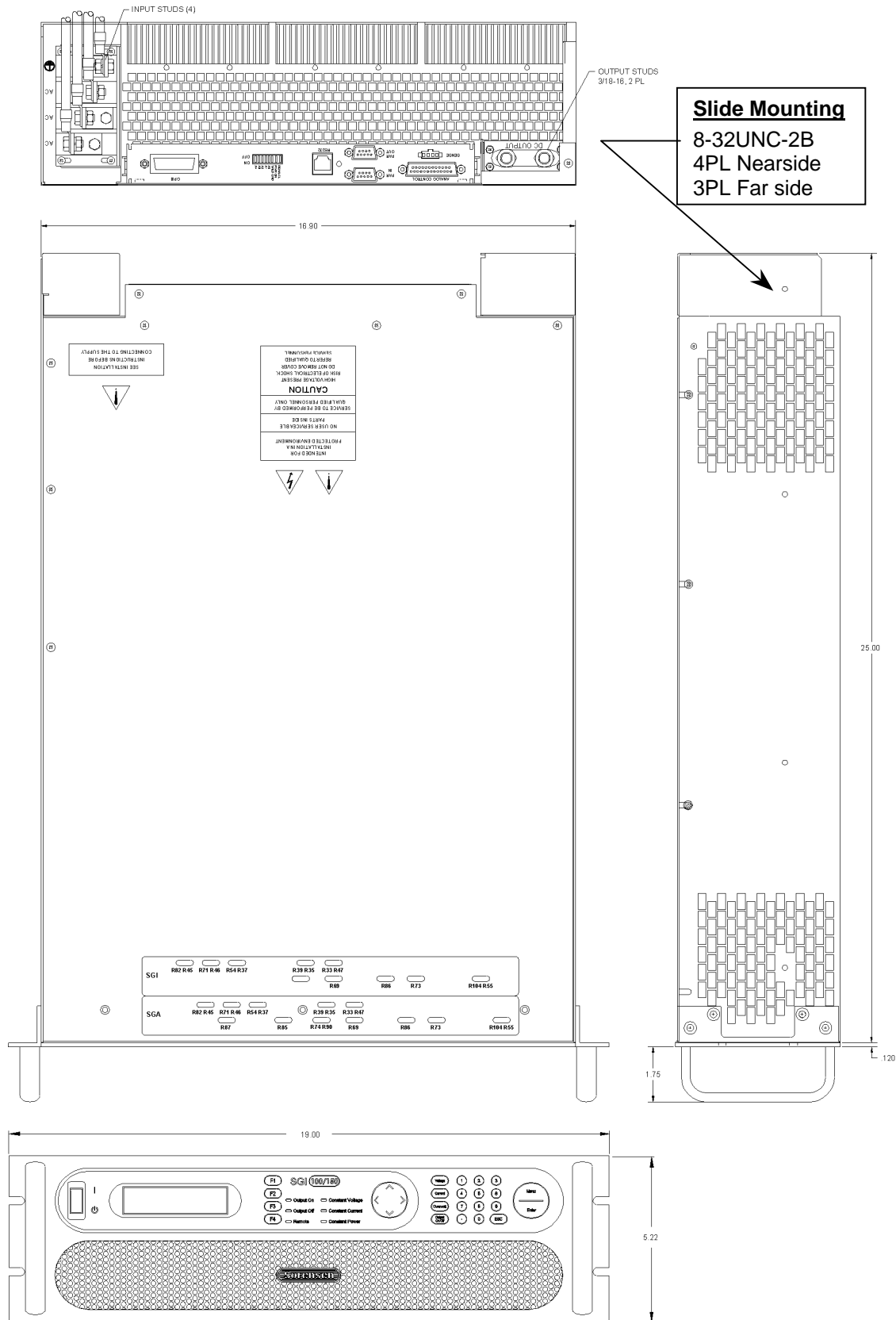

Figure 2-1 SGI Series Outline Drawing, 3U Models 5kW to 15kW

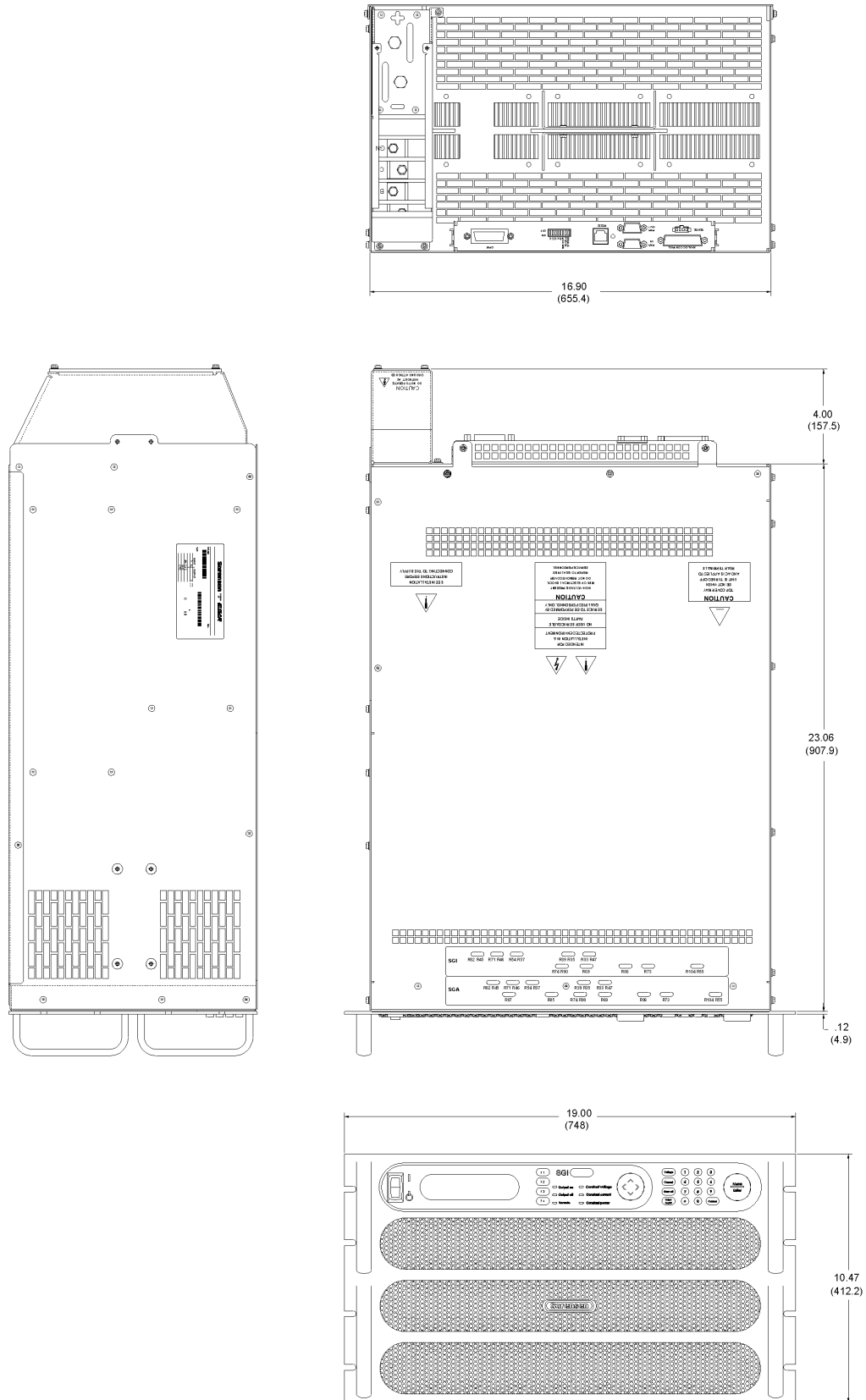

Figure 2-2 SGI Series Outline Drawing, 6U Models, 20kW to 30kW

SECTION 3 OPERATION

3.1 Introduction

The SG series adds powerful functionality and sequence programming to the SG family of dc power supplies. The graphical display, front panel keyboard and context sensitive keys, make setup of the sophisticated functions simple and easy. The following sections provide detailed information on the programming conventions and front panel menu structure of the SGI series.

3.2 Controls and Indicators

3.2.1 Front Panel

Refer to Figure 3–1 and the corresponding descriptions below for an explanation of front panel controls and indicators on the SGI Series power supply.

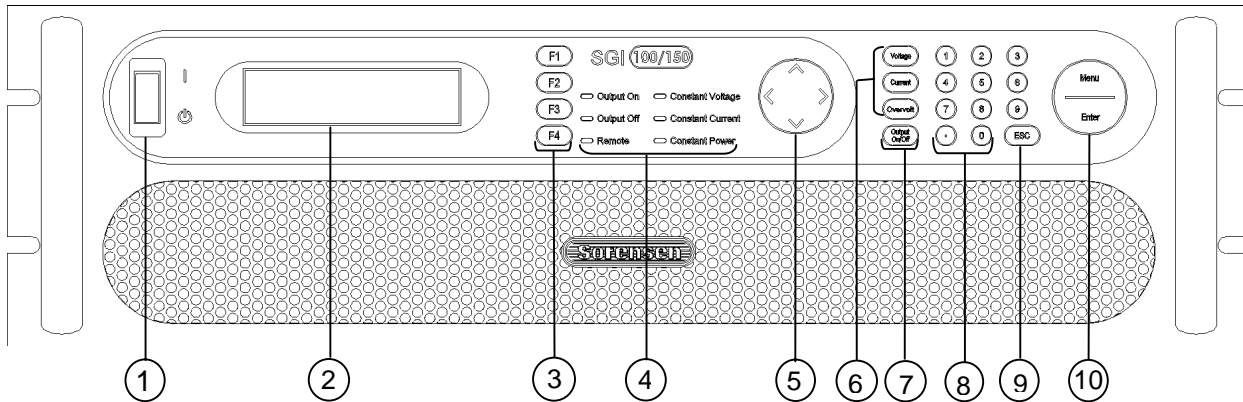

Figure 3–1 Front Panel Controls and Indicators

- 1 ON/OFF SWITCH: Turns on or off power to control unit.
- 2 DISPLAY SCREEN: 256 x 64 graphic VFD, displays menus and settings.
- 3 FUNCTION KEYS F1 - F4: Context-sensitive 'soft' keys execute command specified on display screen by its corresponding key.
- 4 LED MODE INDICATORS: Indicates presently active mode where lit; modes are:
 - Output On (power to output terminals is live)
 - Output Off (power to output terminals is disabled)
 - Remote (supply presently controlled by computer)
 - Constant Voltage (Power supply currently in Voltage mode)
 - Constant Current (Power supply currently in Current mode)
 - Constant Power (Power supply currently in Power mode)
- 5 NAVPAD: Navigates between and within screens; also used for increment/decrement control to make live updates (see Navigation, Section 3.5, and Editing, Section 3.6).
- 6 PROGRAMMING KEYS:
 - VOLTAGE Jumps directly to Voltage programming
 - CURRENT Jumps directly to Current programming
 - OVERVOLT Jumps directly to Overvoltage Protection programming
- 7 OUTPUT ON/OFF KEY: Enables/disables power to the output terminals.
- 8 NUMERIC KEYS 0-9: Used to enter specific values for editable items.
- 9 ESCAPE KEY: Cancels numeric input and/or returns to previous menu.
- 10 MENU/ENTER: Menu returns to Home Menu Page 1 (see Menu Map, Section 3.7). Enter is pressed to set a value input via numeric keys.



WARNING!

The OFF position of the power switch does not remove voltage from the input terminal blocks. Remove all external power before servicing the unit.

3.2.2 Rear Panel

Refer to Figure 3–2 and the corresponding descriptions below for an explanation of rear panel connectors.

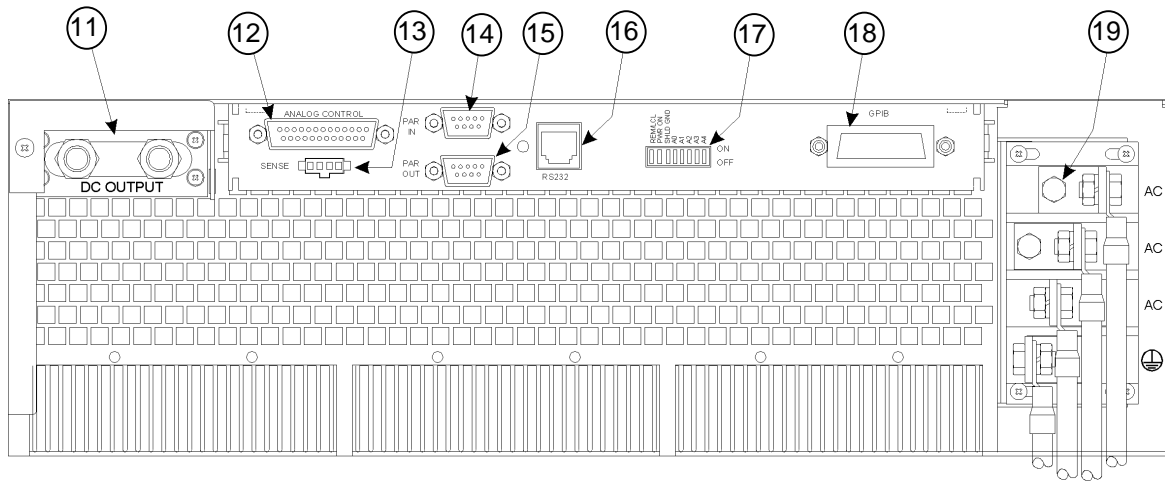



Figure 3–2 Rear Panel Connectors (3U model shown)

- 11 DC OUTPUT: Positive (+) and negative (–) outputs. Threaded studs for 5-15kW models; bus bars for 20-30kW models.
- 12 ANALOG CONTROL Connector (J1): I/O connector for input programming and analog output monitoring signals as well as status indication and remote shutdown signals. See Table 3–1 for individual pin descriptions.
- 13 SENSE Connector (J3): Input connector for load voltage sensing to correct for line drops in the load cables (see Section 3.12).
- 14 PARALLEL IN Connector: Allows master/slave configuration of up to five units when connected to another unit's PARALLEL OUT connector (see Section 3.16).
- 15 PARALLEL OUT Connector: Allows master/slave configuration of up to five units when connected to another unit's PARALLEL IN connector (see Section 3.16).
- 16 RS232 Connector: RJ-11 connector for remote control.
- 17 Dipswitch: Eight–position dipswitch to configure an SGI Series unit with an IEEE option.
- 18 GPIB Connector: Optional connector for remote control.
- 19 AC Input Bus Bars: Connection for 3-phase AC and Ground.

3.3 Initial Start-up and Displays

Upon initial start-up of unit, the following screens will display in sequence after initial splash screens, which show manufacturer's information:

Last Cal Date  displays for seven seconds, showing when the unit was last calibrated. See SG Series Programming Manual for calibration information and how to update "Last Cal Date."

Output-Enabled Warning  appears only if the power on (PwrOn) save setting was set to enable the output (factory default first time power-up state is output off – not enabled), AND the unit is in local mode. This warning tells the user that at the end of a 10-second countdown, the output will be enabled unless the process is aborted. If aborted (i.e., user presses F1 key), the output remains off until the user enables it with the Output On/Off key (see Controls and Indicators, Section 3.2.1). See Section 3.8.2 for changing the Power On default setting.

Home Menu, Page 1  is the final screen to display upon initial start-up of the unit; it is from here that the user may access all menu functions. See Menu Map, Section 3.7, for Home Menu pages 1 through 3 and their submenus. See Functions, Section 3.8, for access and program menu functions.

Note: After 30 seconds of idle time, the Home Menu will change to  the Home Timeout screen. Press F4 to return.



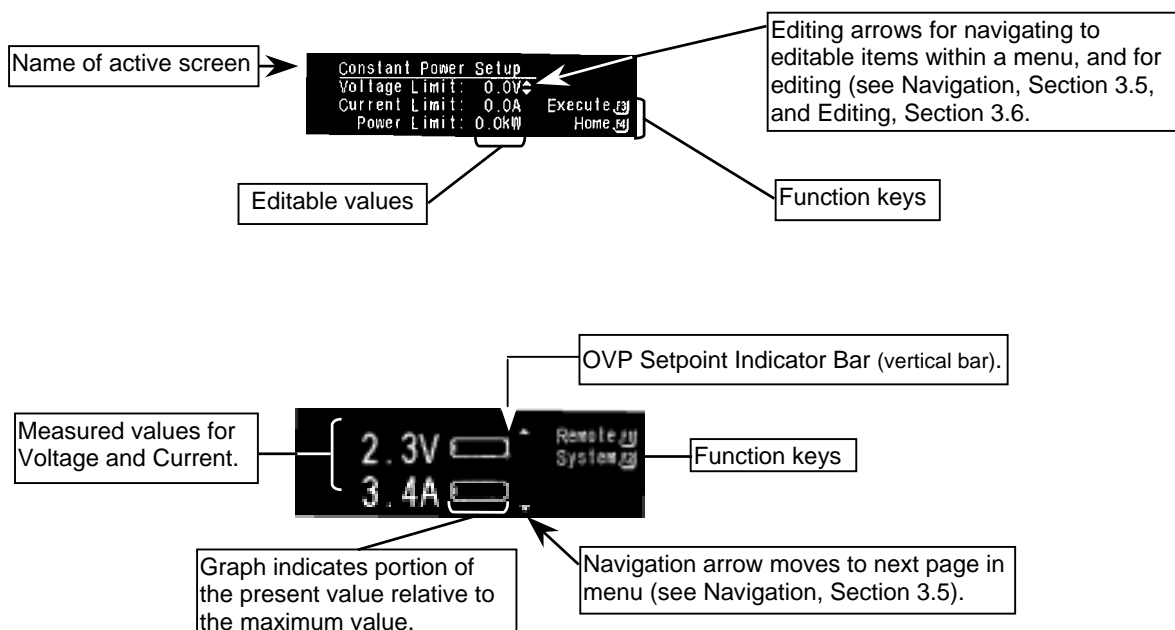



3.4 Display Elements

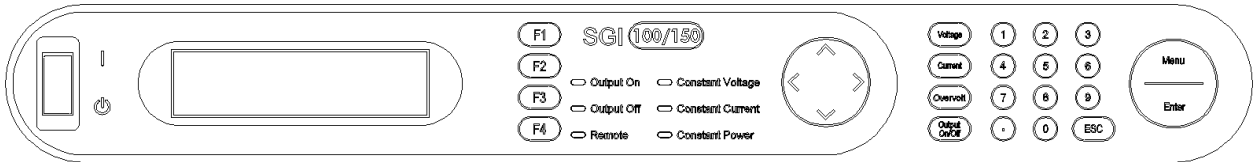

3.5 Navigation

The primary keys used to navigate are: (ESC), (F1-F4), (NavPad), (Menu/Enter) and (V/I/OVP Prog). Their functions are as follows:

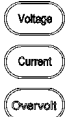

- **(ESC)** – Probably the most important key to remember,  escape works like the back or return button in a browser, bringing the display back one menu level to the previous menu. Continued pressing will eventually return the display to the Home Menu. Escape is not functional in a Fault Screen.
- **(F1-F4)** – To enter a function menu or execute a function, press the corresponding Function key to the right of the function to be entered or executed. Only those function keys defined within that menu will be operational. 
- **(NavPad)** – Used to move between menu pages and between editable items within a menu
 - If a Navigation Arrow is displayed at the top and/or bottom of a screen,  pressing up/down allows the user to move between pages within a menu.
 - If the Editing  Arrow is displayed, pressing left/right allows the user to move between editable items within a menu. If a screen has only one editable item, left/right arrow has no effect. See Editing, Section 3.6.
- **(Menu/Enter)** – Pressing “Menu” from any submenu jumps the display directly to the Home Menu, page 1, with one exception - see NOTE below. Pressing “Enter” moves the editing arrow to the next editable item in the menu, similar to the right arrow on the NavPad. 
- **(Programming keys)** – Pressing the “Voltage,” “Current,” or “Overvolt” programming key displays the Default Programming menu with the editing arrow at the corresponding function in that menu - see NOTE below. 

NOTE: The “Menu” key and the “Voltage,” “Current” and “Overvolt” programming keys do not function while running a sequence, paused in a sequence, in sequence single step mode or running in power mode.

3.6 Editing



WARNING!

While Output is enabled, the editable item being programmed (Voltage, Current, Over-Voltage or Power) is “Live Updated” and takes effect on the output terminals immediately.

The primary keys used to edit are: (ESC), (F1-F4), (NavPad), (Menu/Enter) and (Keypad 0-9). Their functions are as follows:

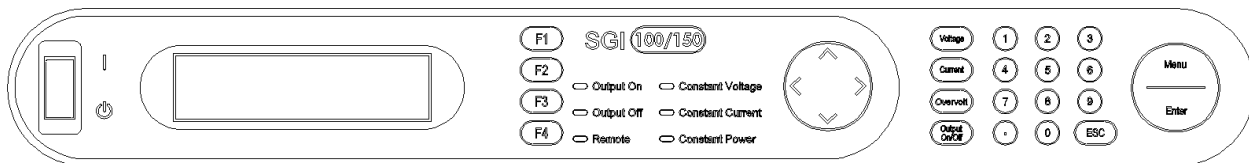

- **(ESC)** – In editing, “Escape” functions like the escape key on a keyboard. While programming an editable item, the escape key can be used to clear the entered value before it is accepted and takes effect. This leaves the program function setting at the original value before editing began.
- **(F1-F4)** – Not used to program editable items directly, Function keys may be used to save, recall, cut, past, insert or delete edits made in some menus. These functions will be indicated to the left of the function keys in the specific menus they are used.
- **(NavPad)** – The NavPad functions as an increment/decrement editing and “Live Update” (Pressing Up/Down). “Live Update” means the value or item displayed due to an edit change from the NavPad, is actively changing the operation of the supply in real time when Output is On. This includes programming editable items as well as scrolling through option lists within a menu.
 - **Programming editable items:** If an Editing Arrow  is displayed, pressing the NavPad up or down incrementally adjusts the editable item value adjacent to the Editing Arrow by the least significant digit per press in the respective direction. If the NavPad is pressed up or down and held, the selected editable item will accelerate from set point to full-scale or from set point to zero, respectively, within 15 seconds. If the output is enabled, the output terminals will “Live Update” with the programmed changes.
 - **Scrolling through option lists:** Pressing the NavPad up or down incrementally scrolls through the listed items available and “Live Update” selects the item being displayed. Option lists wrap around from top to bottom (pressing NavPad down) and bottom to top (pressing NavPad up).
- **(Menu/Enter)** – “Enter” is used to accept a value edited or entered using “Keypad 0-9.” When “Enter” is pressed the value edited is programmed into memory and the Editing Arrow moves to the next editable item. If the output is enabled, the programmed value takes effect on the output terminals immediately after “Enter” is pressed.
 - “Menu” is not used to edit.

- **(Keypad 0-9)** – Similar to the number pad on a phone, “Keypad 0-9” is used to program numeric values into editable items using single digit entry. “Enter” must be pressed to program the edited value into memory. The decimal key is for future use.
 - If the editing arrow is displayed, pressing “Keypad 0-9” will activate the editable item to the left of the Editing Arrow and display the number(s) pressed. As the first number is input, the display begins with the least significant position first, and shifts left as additional numbers are pressed (see Example below). Once the user starts to input a value, the Editing Arrow will begin to blink – a blinking Edit Arrow indicates that the value entered has not been programmed into memory; also, both the NavPad right/left arrows and the NavPad up/down “Live Update” are no longer operational in this condition. The user must either abort (see 3.6.1 Aborting an Edit, below) or press Enter to accept the inputted value.

Example: Programming 50V

Navigate to voltage programming by pressing the “Voltage” programming key. The Default Programming menu is displayed and the Editing Arrow is to the right of the “Set Volt” editable item value. Begin entering the value:

- Press “5” The display “Set Volt” value reads, “0.5V” (Notice the Editing Arrow begins to blink).
- Press “0” The display “Set Volt” value reads, “5.0V”
- Press “0” The display “Set Volt” value reads, “50.0V”
- Press “Enter” The value is programmed into memory. (Notice the Editing Arrow stops blinking and moves automatically to the next editable item. This means the value has been programmed).

3.6.1 Aborting an Edit

- “Escape” can be used to cancel an edit before it is accepted. When pressed, the value of the editable item displayed will default to the previous value before editing began. The Editing Arrow does not change position and will no longer be blinking.

NOTE: If an invalid or out-of-range value is entered with either the NavPad or “Keypad 0-9”, it will be ignored and the user will be alerted through an audible signal.

3.7 Menu Map

3.7.1 Home Menu

Home Menu is made up of three pages from which the user may navigate to the various function or command screens.

Return to Home Menu Page 1 from anywhere in system by pressing Escape as needed, **ESC** or Menu, except as noted in Section 3.5



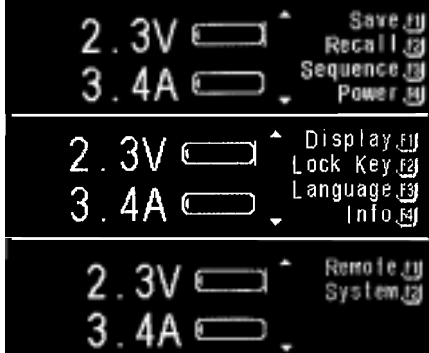

Page 1

Page 2

Page 3

Toggle between pages by pressing up or down on the NavPad. See Section 3.2, Controls and Indicators.



NavPad

3.7.2 Default Programming Menu

Access this menu directly with the hard-code keys, Voltage, Current, or Overvoltage, on the Control Panel. See Section 3.8.1 for details.



3.7.3 Navigating from Home Menu Page 1



| | |
|--|---|
| <p>Volt Curr OVP Out</p> <p>0.0 0.0 110.0 f</p> <p>Save In Location: PerDn</p> <p>0.5 10.0 110.0 f</p> | <p>SAVE - See Section 3.8.2 for details.</p> |
| <p>Volt Curr OVP Out</p> <p>0.0 0.0 80.0 f Recall 0</p> <p>0.0 0.0 80.0 Recall 1</p> <p>0.0 0.0 80.0 Recall 2</p> | <p>RECALL - See Section 3.8.3 for details.</p> |
| <p>Sequence Menu Start</p> <p>Test ID SStep</p> <p>TEST01 Program</p> <p>Del Test</p> | <p>SEQUENCE See Sections 3.7.6 for submenus and 3.8.4 for details.</p> |
| <p>Constant Power Setup</p> <p>Voltage Limit: 0.0V</p> <p>Current Limit: 0.0A Execute</p> <p>Power Limit: 0.0kW Home</p> | <p>POWER - See Sections 3.7.8 for next screens and 3.8.5 for details.</p> |

3.7.4 Navigating from Home Menu Page 2



| | |
|--|---|
| <p>Display Brightness</p> <p>Adjust</p> <p>0% 100%</p> | <p>DISPLAY - See Section 3.8.7 for description.</p> |
| <p>2.3V 3.4A</p> <p>OVP 110.0V 0.0kW Unlock</p> | <p>LOCK KEY - See Sections 3.7.11 for next screen, and 3.8.8 for details.</p> |
| <p>Language Menu</p> <p>Select Language:</p> <p>English</p> | <p>LANGUAGE - See Section 3.8.9 for details.</p> |
| <p>Supply info</p> <p>PTN 5550219-01</p> <p>Ser Num: E1025008548</p> <p>1.01</p> | <p>INFO - See Section 3.8.10 for details.</p> |

3.7.5 Navigating from Home Menu Page 3

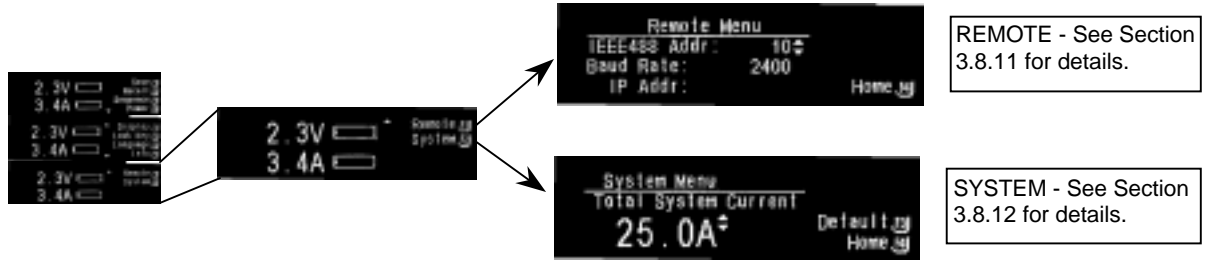

3.7.6 Sequence Menu

Refer to Section 3.8.4.2, Basic Sequence Operation.

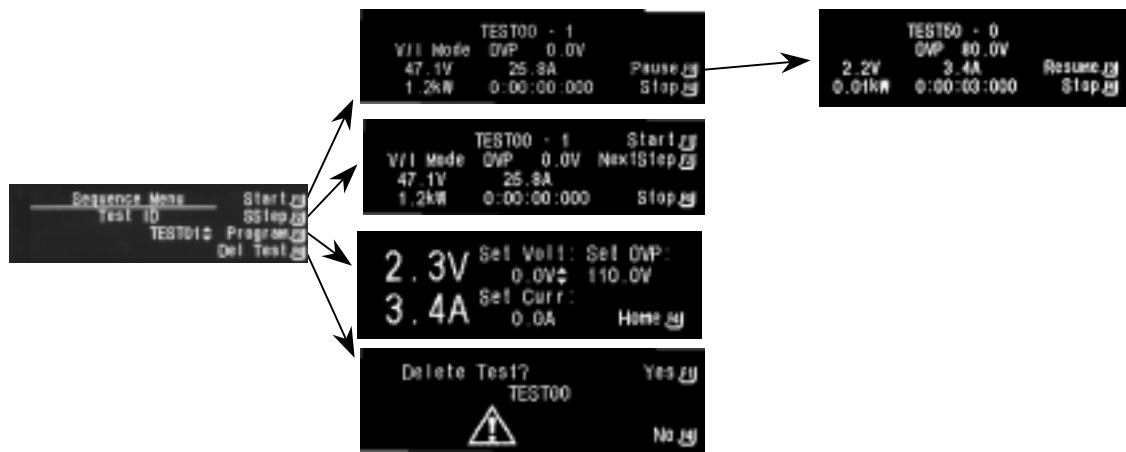

3.7.7 Sequence Programming Operation

The screens in this section show the various operations available for programming a sequence. See Section 3.8.4.3 for details on step operations.

A grid of 15 screens showing various sequence programming operations for TEST00 - 1:

- NDP:** CopyStep, PasteStep, Insert, Delete.
- V/I Mode:** OVP: 0.0V, I/O: 0.0A, Time: 0:00:00.000. CopyStep, PasteStep, Insert, Delete.
- Ramp V:** Vi: 0.0V, Vf: 0.0V, Time: 0:00:00.000. CopyStep, PasteStep, Insert, Delete.
- Ramp I:** OVP: 0.0V, Ii: 0.0A, If: 0.0A, Time: 0:00:00.000. CopyStep, PasteStep, Insert, Delete.
- CP Mode:** OVP: 0.0V, Limits: 0.0V, 0.0A, Time: 0:00:00.000. CopyStep, PasteStep, Insert, Delete.
- Repeat:** CopyStep, PasteStep, Insert, Delete.
- Subcall:** TEST00. CopyStep, PasteStep, Insert, Delete.
- Return:** CopyStep, PasteStep, Insert, Delete.
- Loop:** Count: 5. CopyStep, PasteStep, Insert, Delete.
- Next:** CopyStep, PasteStep, Insert, Delete.
- Step:** CopyStep, PasteStep, Insert, Delete.
- Gate:** TEST00. CopyStep, PasteStep, Insert, Delete.
- Pause:** CopyStep, PasteStep, Insert, Delete.

3.7.8 Constant Power Setup Menu

See Section 3.8.5 for details.

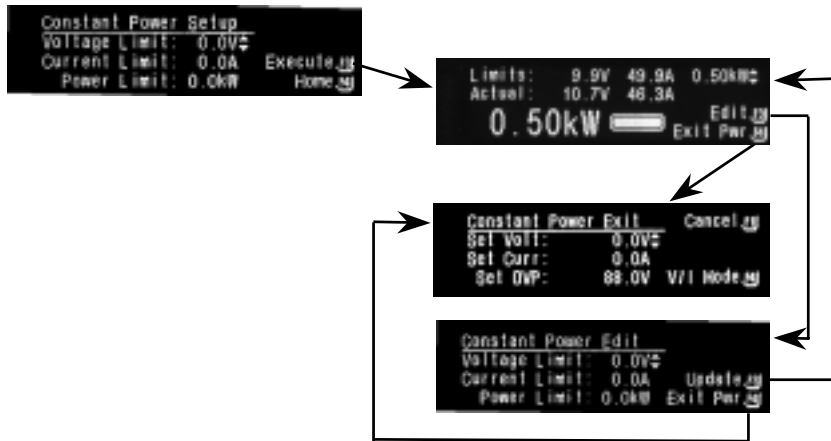

3.7.9 Remote Example Screens

Remote screens display when operation is controlled by computer. Pressing F4 from any Remote screen returns operation to Local Mode.

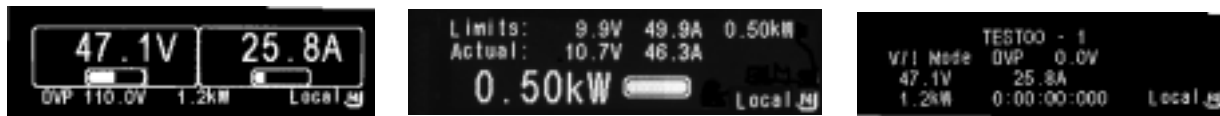

3.7.10 Warning Screens

| | | |
|---|---|---|
| | | |
| <p>General hardware failure has occurred. Press F4, Clear Fault, to reset the unit.</p> | <p>Overvoltage Protection was tripped. Press F4, Clear OVP; the unit will reset in 4 seconds.</p> | <p>Displays when a saved setting with Output On is recalled. See Section 3.8.3 for details.</p> |

3.7.11 Other Screens

| | | |
|---|----------------------------------|---|
| | | |
| <p>Home Menu Time Out Screen displays after 30-second idle.</p> | <p>From Home Menu Page 2, F2</p> | <p>Screen to confirm Unlock control panel keys.</p> |

3.8 Functions

3.8.1 Voltage, Current, and Overvoltage Protection Programming

Press Voltage, Current, or Overvoltage key on Control Panel to go directly to the Default Programming Menu. The editing arrow will be displayed next to the corresponding item pressed.



3.8.1.1 Programming Voltage

Go directly to Voltage programming by pressing the  key. The Default Programming menu is displayed and the Editing Arrow is to the right of the "Set Volt" editable value. Edit the value by NavPad up/down or by entering the value with "Keypad 0-9". For more details see Section 3.6, Editing.

3.8.1.2 Programming Current

Go directly to Current programming by pressing the  key. The Default Programming menu is displayed and the Editing Arrow is to the right of the "Set Curr" editable value. Edit the value by NavPad up/down or by entering the value with "Keypad 0-9". For more details see Section 3.6, Editing.

3.8.1.3 Programming Overvoltage

Go directly to Overvoltage trip point programming by pressing the  key. The Default Programming menu is displayed and the Editing Arrow is to the right of the "Set OVP" editable value. Edit the value by NavPad up/down or entering the value with "Keypad 0-9". For more details see Section 3.6, Editing.

3.8.2 Save

There are 10 memory locations (PwrOn and 1 through 9) into which a programmed output configuration of Voltage, Current, OVP (Overvoltage Protection trip point) and Output Condition can be stored. From Home Menu Page 1 press (F1) to enter the Save menu. Voltage, Current and OVP values programmed in the Default Programming menu will be pulled into the Save menu, top line, upon reaching that menu. In addition, the present output condition, output engaged or output disabled, will be indicated.

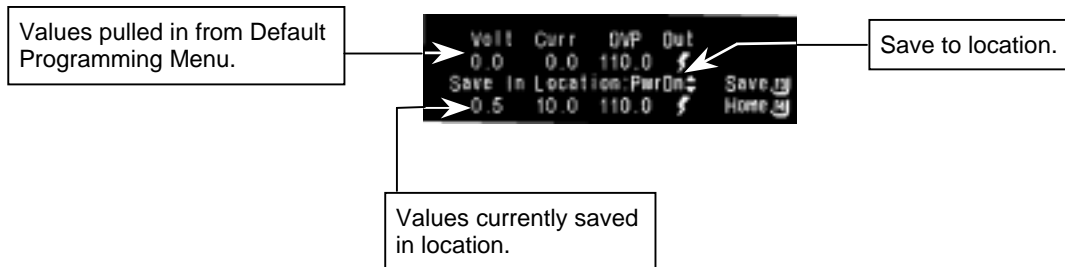

- **Edit Voltage, Current and OVP:**
 - Toggle between the editable items using the NavPad and edit Voltage, Current and OVP to appropriate values (see Section 3.6 for editing details).
- **Edit Output Condition:**
 - Pressing NavPad up/down will toggle the output condition indicator **on** (⚡) to indicate the output will be enabled and **off** (*blank*) to indicate the output will be disabled.

Note: Edits will not take effect until the configuration is saved.
- **Saving a configuration:**
 - With the Editing Arrow adjacent to “Save Location” pressing NavPad up/down allows the user to scroll through the list of memory locations (PWR ON and 1-9). Select the appropriate location and press (F3) to save the configuration to that location. The bottom line of the screen will update with the configuration information saved. Press (F4), “Escape” or “Menu” key to exit to the Home Menu Page 1 at any time.
- **Saving to PWR ON:**
 - “PWR ON” is a unique “Save Location.” If a configuration is saved to “PWR ON” location, the next time the ON/OFF front panel switch is cycled, the SGI will power up into the state this configuration was saved. If the Output Condition was saved **on** (⚡), a warning screen will be displayed at power up. The user will have 10 seconds to press (F1) and abort the operation. If the count times out, the supply output terminals will be live and programmed to the saved configuration values. See Section 3.3 for Output-Enabled Warning! All other saved configuration locations must be recalled to become active. See Section 3.8.3 Recall.

3.8.3 Recall

There are 10 memory locations (as above, PwrOn and 1-9) from which a programmed output configuration of Voltage, Current, OVP (Overvoltage Protection trip point) and Output Condition can be recalled.

| Volt | Curr | OVP | Out |
|------|------|------|------------|
| 0.0 | 0.0 | 60.0 | ⚡ Recall 0 |
| 0.0 | 0.0 | 88.0 | Recall 1 |
| 0.0 | 0.0 | 88.0 | Recall 2 |

From Home Menu Page 1 press (F2) to enter the Recall menu. Using the NavPad up/down arrows scroll through the list of saved configurations. Recall a saved configuration by pressing the function key (F2-F4) to the right of that configuration. If a configuration was saved with the Output Condition **on** (⚡) and that configuration is recalled, a warning screen (Menu Map Section 3.7.9) will be displayed *. The user is given the option to press Yes (F1) to enable or No (F4) to disable the output. All other settings will be programmed according to the recalled configuration regardless of this choice.

* **Note:** The warning screen will not appear if the Output is already enabled.

3.8.4 Sequencing

3.8.4.1 Introduction

The SGI sequencing function allows the user to set up the supply to automatically run a series of voltage, current and power mode operations. This is especially useful for setting up the supply to test to compliance standards, or unburdening the test computer in automated testing

applications. Via RS232 or IEEE-488 an external computer can trigger the sequences (see SG Series Programming Manual). Up to 50 sequences may be stored, with each sequence containing up to 20 individual steps. With the ability to string sequences together and an extensive list of step functions such as ramping, looping, gotos and subroutine calls, the user can define a nearly infinite variety of test sequences.

The following sections will assist the user in programming, testing and running a sequence from the front panel.

3.8.4.2 Basic Sequence Operation

To access the main Sequencing menu press F3 from Home Menu Page 1. From here any one of 50 sequences may be selected. The default names for sequences are TESTxx where xx is a number from 01 to 50. Using SCPI commands via the RS232 or IEEE-488 interface, the user may rename these test sequences with meaningful names of up to 15 characters (see SG Series Programming Manual).

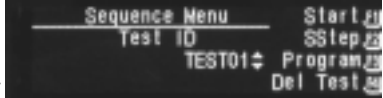

CAUTION - RESTRICTIONS ON SEQUENCE PROGRAMMING



In order to allow maximum flexibility for generating small incremental changes during a test sequence, the SGI allows 1ms time resolution on each step. With this capability, however, it is possible to create output changes that generate large, and potentially damaging, currents in the output capacitors of the unit.

When creating test sequences, please use the following guidelines to prevent damage to the unit (see Note):

- *Estimate the AC frequency and peak-to-peak voltage (Vp-p) of the desired test sequence.*
- *Convert the estimated Vp-p to a % of maximum output voltage (e.g. if Vp-p is 10V and maximum voltage of the supply is 100V, then %Vp-p – 10%)*
- *Verify that the frequency and %Vp-p does not exceed the values below:*

| Frequency | % Vp-p |
|-----------|--------|
| 10Hz | 25% |
| 50Hz | 5.0% |
| 100Hz | 2.5% |
| 150Hz | 1.67% |
| 200Hz | 1.25% |

Another consideration is the actual rise and fall capabilities of the output of the supply. Although damage will not occur, the shape of the output waveform will be affected by these differences. These vary widely depending on the load conditions, contact the factory for further information.

NOTE: *Contact the factory for detailed information if the desired waveform exceeds the recommended limits as discussed.*

To change the test sequence, use the NavPad up/down to scroll through the test list. From this menu the user may Start (F1), Single Step (F2), Program (F3) or Delete (F4) a sequence.

START, press F1 from the main Sequence Menu to start and run a test sequence. The display will show the test sequence name and step number (e.g., TEST01-12, Sequence TEST01, step 12). It will also indicate the current operation being executed (see Section 3.8.4.3 Operations) and will display voltage, current, OVP, power and time remaining for that step. The time format is hhhh:mm:ss:sss (last three digits are milliseconds).

User may pause or stop the test at any time by pressing either F3 to pause or F4 to stop the sequence. The output will pause or stop in the same state as the test step was when the key was pressed. Pressing F3 (Resume) restarts the sequence from the beginning of the same step. (Note: For steps with voltage or current ramps, the step will resume at the beginning of the ramp and not at the point at which the ramp was paused.) Pressing F4 (Stop) to stop the sequence returns the display to the main Sequence Menu.

SINGLE STEP, press F2 from the main Sequence Menu to single step through a test sequence. The display will show the test sequence name and step number. It will also indicate the current operation being executed and display voltage, current, OVP, power and time remaining for that step.

User may start the sequence after any step causing it to run in continuous mode, by pressing F1 (Start). Note that the sequence will start from the beginning of the test sequence, not the beginning of the current step. To continue to single step through each sequence step, press F2 (NextStep). Pressing F2 NextStep before the timer ends, will replay the step. Pressing F4 (Stop) allows the user to stop the single step mode, and the display returns to the main Sequence Menu.

PROGRAM, press F3 from the main Sequence Menu to program a test sequence. The Test Sequence submenu shows the name of the current test sequence and step number. In addition it displays the primary operation of the test step (there are 13 different operations, see Section 3.8.4.3 Operations below). From this submenu the user may copy (F1), paste (F2), insert (F3) or delete (F4) a test step.

CopyStep (F1) – copies the current step characteristics into a buffer for later recall using the PasteStp (F2) function.

PasteStp (F2) – pastes the current characteristics from the copy buffer into the existing test step.

Insert (F3) – inserts a new step before the currently displayed test step. The default operation in the new step is set to NOP.

Delete (F4) – deletes the current test step from the test sequence, and inserts NOP into step 20 of the sequence.

DEL TEST, press F4 from the main Sequence Menu to delete the entire currently selected test sequence. If Del Test is selected, a warning screen will appear prompting the user to either confirm (Yes – F1) or cancel (No – F4) the delete action. Note that deleting a test actually fills each test step in the sequence with a NOP (see Section 3.8.4.3), and fills Step 21 with STOP operation.



3.8.4.3 Operations

When programming a test sequence (see Section 3.8.4.2 above) each step operation can be any one of thirteen different functions. To access those functions, from Home Menu Page 1 press F3 (see Menu Map Sections 3.7.2, 3.7.5, and 3.7.6), and use the NavPad to scroll

through the various step operations (see Section 3.5 for Navigation) while in the Sequence Step Programming submenu.

1. Once an operation has been selected for the present step, navigate to the editable items and input values for each setting as appropriate (see Section 3.6 Editing).
2. After programming a step, navigate to the step-number location on the screen and scroll to the next step number to be programmed.
3. Once at the next step number to be programmed, start again by choosing an operation for that step and continue as described above.
4. At the end of the sequence or to abort the sequence, press either the Escape key or Menu to jump to the Save screen. F1 (Yes) saves the sequence (in non-volatile memory) and returns to main Sequence Menu. F4 (No) will *retain the current changes only until the power supply is turned off*. The next power on restores the sequence to its previous condition.

The following are descriptions for each sequence operation:

NOP - No Operation. Used as a placeholder in the test sequence, no values are changed during this step, and it does not add time to the sequence.



V/I Mode - Voltage/Current Mode. This operation sets the voltage, current and OVP to the programmed values for the set period of time during the sequence step. Navigate to each editable item to input values for Voltage, Current, Overvoltage Protection and duration.

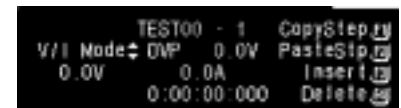

Ramp V - Ramp Voltage. This operation allows the user to ramp the output voltage from an initial, or start, value (Vi) to a final, or stop, value (Vf) over the time period specified. Internally the unit uses Vi, Vf and the time to calculate an appropriate ramp function to drive the output during the test step. Use the NavPad to set the OVP, initial Voltage (Vi), final Voltage (Vf), Current limit, and duration.

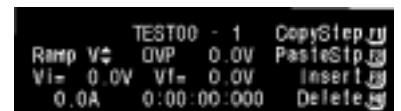

Ramp I - Ramp Current. This operation allows the user to ramp the output current from an initial, or start, value (Ii) to a final, or stop, value (If) over the time period specified. Use the NavPad to set the OVP, initial Current (Ii), final Current (If), Voltage limit, and duration.



CP Mode - Constant Power Mode. This operation is similar to the V/I mode, except it sets the supply in a constant power mode (See section 3.8.5). Use the NavPad to input values for OVP, Voltage limit, Current limit, Constant Power setting and duration.

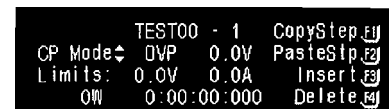

Repeat. This operation returns to the beginning of the test cycle (this could be a prior test sequence or the beginning of the current test sequence, depending on the number of branching and subcalls used in the affected sequences) and repeats all proceeding steps a single time. Once executed, the sequence continues to execute all remaining steps after the Repeat



command. To repeat the preceding steps more than once, use the Loop operation.

Subcall. This operation calls another test that runs as a sub-sequence. If that sub-sequence includes a Return command, execution of the primary sequence resumes at the step following the Subcall step. Use the NavPad to scroll to the desired Test name and change as appropriate.



Return. This operation causes execution to resume at the step immediately following the most recent Subcall. When occurring in a primary sequence, without a prior Subcall, Return stops execution of the test sequence. Return is one of only three operations that may be used in step 21 of a test sequence.

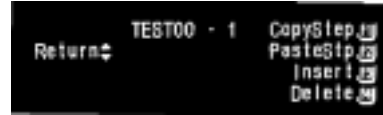

Loop. This operation causes the unit to repeat all steps between the Loop operation and the Next operation for the specified number of counts. Use the NavPad to set the Count for the total number of loops. Use the Next operation after the last step to be repeated. Once the Loop has completed the set number of counts, the unit will continue to execute the remainder of the sequence.



Next. Next is used at the end of a Loop to signify the end of the looped sequence. If Next is not preceded by the Loop operation, *this is an INVALID condition*. If the program encounters the Next command under these conditions, the sequence will abort and the output power to the terminals will be disabled.

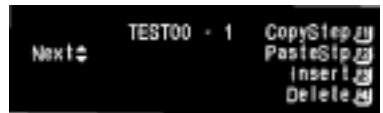

Stop. Stops the test sequence execution and disables output power to the terminals by programming down to zero volts and zero amps. The Stop operation may be used in step 21 of a sequence.



GOTO. This operation allows the sequence to exit the existing test sequence and begin another test sequence. Goto is used to string together multiple sequences for a single test. The Goto operation may be used in step 21 of a sequence.



Pause. This operation suspends execution of the sequence and waits for operator input to press either the Resume key to continue the sequence or the Stop key to end the sequence.



3.8.4.4 Sequencing Example

The following provides an example of programming and running a test sequence.

A typical burn-in sequence requires the voltage to the device-under-test (DUT) to ramp up to a nominal voltage, allow the unit to soak at that voltage for a period of time, then 'bump' up that voltage to another level, soak, etc., then return the output back to zero. In some cases, an on/off power cycle sequence may also be required. Figure 3.3 below provides a graphical representation of this example burn-in sequence.

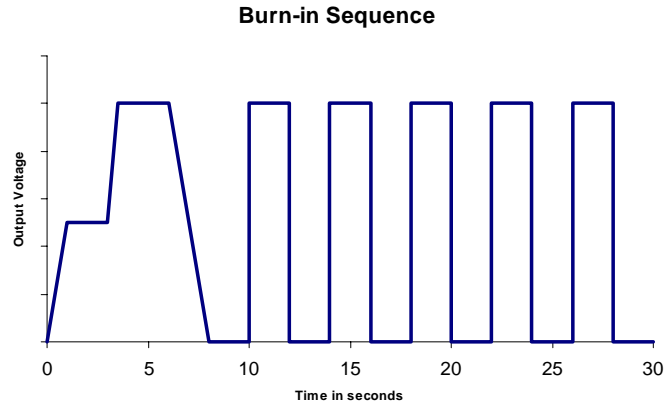

Figure 3–3 Burn-in Sequence Example

To begin programming a sequence it is important to know the exact settings for each step of the sequence. In this case we will program two sequences (the first being the up/down ramp sequence and the second the on/off sequence) and string these two together using a Goto command.

The example sequence will perform the following:

Sequence 1 – Up/Down Ramp

- Step 1 – Ramp the output voltage from 0V to 20V over a 1 second period
- Step 2 – Hold the voltage at 20V for 2 seconds
- Step 3 – Ramp the voltage from 20V to 40V over a 500ms period
- Step 4 – Hold the voltage at 40V for 2.5 seconds
- Step 5 – Ramp the voltage from 40V to 0V over a 2 second period
- Step 6 – Hold the voltage at 0V for 2 seconds
- Step 7 – Go to sequence 2

Sequence 2 – On/Off Loop

- Step 1 – Begin a loop and set the count to 5
- Step 2 – Turn on the voltage to 40V for 2 seconds
- Step 3 – Turn off the voltage for 2 seconds
- Step 4 – Execute the Next loop until all 5 are complete
- Step 5 – Stop the sequence

Run the sequence.

To program these sequences, do the following:

Sequence 1 – Up/Down Ramp

From the Home Menu Page 1, select F3 to enter the main Sequence Menu. Use the NavPad up/down to select the sequence (Test ID) labeled TEST01. Press F4 (Del Test) to reset all steps in TEST01 to a NOP condition. This establishes a known state for this sequence. Press F3 to enter the Sequence Step menu.

Step 1 – Ramp the output voltage from 0V to 20V over a 1 second period

From the Sequence Step menu, use the NavPad to set the test step to the first step, TEST01-1. Use the NavPad to set the operation to Ramp V mode. Set OVP to an appropriately high level (60V for this example), Vi to 0V, Vf to

20V and current to a nominal 10A (for this example we assume there is no load – or a very light load – connected to the output). Set the time duration to 1 second or (0:00:01:000). Once these values are set, press the F1 key to copy this setup into the copy buffer for later use.

Step 2 – Hold the voltage at 20V for 2 seconds

Use the NavPad to change to the next step (TEST01-2). Select the V/I Mode operation and set the OVP to 60V, voltage to 20V, current to 10A and time duration to 2 seconds.

Step 3 – Ramp the voltage from 20V to 40V over a 500ms period

Use the NavPad to change to the next step (TEST01-3). Use the F2 key to paste in a copy of the previously saved Ramp V step. Make changes to this step by changing Vi to 20V, Vf to 40V and the time duration to 500ms (0:00:00:500)

Step 4 – Hold the voltage at 40V for 2.5 seconds

Use the NavPad to change to the next step (TEST01-4). Select the V/I Mode operation and set the OVP to 60V, voltage to 40V, current to 10A and time duration to 2.5 seconds.

Step 5 – Ramp the voltage from 40V to 0V over a 2 second period

Use the NavPad to change to the next step (TEST01-5). Use the F2 key to paste in a copy of the previously saved Ramp V step. Make changes to this step by changing Vi to 40V, Vf to 0V and the time duration to 2 seconds.

Step 6 – Hold the voltage at 0V for 2 seconds

Use the NavPad to change to the next step (TEST01-6). Select the V/I Mode operation and set the OVP to 60V, voltage to 0V, current to 10A and time duration to 2 seconds.

Step 7 – Go to sequence 2

Use the NavPad to change to the next step (TEST01-7). Select the Goto operation and set the next step to TEST02. Press the ESC or Menu key to move to the Save Sequence screen and press F1 for Yes.

Sequence 2 – On/Off Loop

From the Home Menu Page 1, select F3 to enter the main Sequence Menu. Use the Navigation arrows to select the sequence labeled TEST02. Press F4 (Del Test) to reset all steps in TEST02 to a NOP condition. Press F3 to enter the Sequence Step menu.

Step 1 – Begin a loop and set the count to 5

Use the NavPad to change to the first step (TEST02-1). Select the Loop operation and set the count to 5.

Step 2 – Turn on the voltage to 40V for 2 seconds

Use the NavPad to change to the next step (TEST02-2). Select the V/I Mode operation and set the OVP to 60V, voltage to 40V, current to 10A and time duration to 2 seconds. Press F1 to copy this step to the copy buffer.

Step 3 – Turn off the voltage for 2 seconds

Use the NavPad to change to the next step (TEST02-3). Press the F2 key to paste the previously saved step into this step. Set the voltage to 0V, all other settings remain the same.

Step 4 – Execute the Next loop until all 5 are complete

Use the NavPad to change to the next step (TEST02-4). Select the Next operation.

Step 5 – Stop the sequence

Use the NavPad to change to the next step (TEST02-5). Select the Stop operation. Press the ESC or Menu key to move to the Save Sequence screen and press F1 for Yes.

This completes programming of the sequences.

To run this sequence, from Home Menu Page 1, press F3 to enter the main Sequence menu. Select TEST01 test sequence and press F1 to start the sequence. The display will show progress of the sequence and should complete in approximately 30 seconds.

3.8.5 Power Mode

The Constant Power Mode allows the supply to regulate the output to a constant power setting as opposed to the more common constant voltage or constant current modes of operation (see Section 3–9). (Note: This mode is intended primarily for loads with response times greater than approximately 10ms). While in this mode, the supply will continually adjust the voltage and current levels to attempt to maintain a constant power to the load. In order to provide additional protection for the load, voltage, and current limits may be set while in the Constant Power mode. If the unit cannot regulate to the Constant Power setting due to load conditions, it will regulate either at the voltage or current limit depending on the load demand. See figure below.

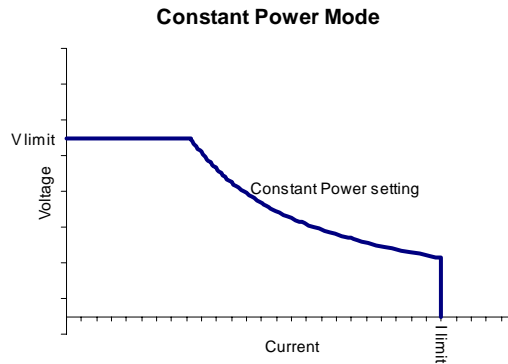
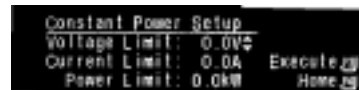
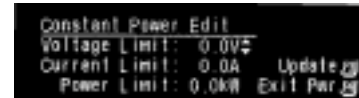

Figure 3–4 Constant Power Example

To access the Constant Power Setup menu, press the F4 key from Home Menu Page 1. Navigate to each editable item and enter the appropriate values. Press F3 to execute (the display jumps to Constant Power screen) or F4 to abort (the display returns to Home Menu Page 1).



From Constant Power screen, the user may either edit the limits again or exit Power mode. F3 jumps to Constant Power Edit screen, and after inputting new values, press F3 to make those changes effective and jump back to Constant Power Screen. Or press F4 to ignore the changes and jump to Constant Power Exit.



From Constant Power Exit, F1 cancels the command to exit and jumps back to Constant Power screen, or F4 exits Constant Power and jumps to Home Menu Page 1 with the Voltage, Current, and OVP values as set. (See Menu Map Section 3.7.7).

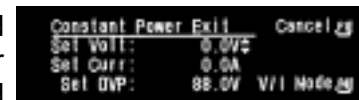

3.8.6 Home Timeout

The display jumps to this screen when the system has been idle for 30 seconds. Press Escape or F4 to return to Home Menu Page 1.



3.8.7 Display Brightness

Navigate from Home Menu Page 2, F1; use NavPad to dim or increase the brightness. F1 saves the adjusted setting for the remainder of the session and for future power-ups. F4 maintains the



setting for the remainder of the session and returns the brightness to its previously saved level at next power-up.

3.8.8 Lock Key

To prevent changes due to accidental pressing of the keys, Lock the keys from Home Menu Page 2, F2. This screen appears until F4 is pressed; a confirmation screen will appear (see Section 3.7.10, Other Screens) before returning to Home Menu.

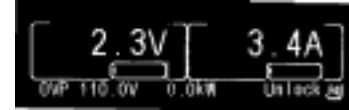

NOTE: Lock Key only works while in the normal constant Voltage or constant Current mode.

3.8.9 Language

The Language submenu allows the user to change the default language for the menu selections. To select this menu, from Home Menu Page 2 press F3 to go to the Language Menu and select a language to work in. Pressing F1 will save the selection and exit the Language Menu. The next time the unit is powered up it will be in the last saved language. Pressing F4 will keep the selected language only for the remainder of the session and will revert to the previously saved language at next power-up.

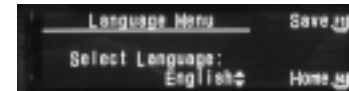

Foreign Language

If the unit is set to a language foreign to the user, press the escape key until Home Menu Page 1 appears. (Even in a foreign language, the Voltage and Current values will still display: value with the letter V and value with the letter A, respectively. Also, there will be only one interscreen navigation arrow, which is located at the bottom of the screen). Use the NavPad to scroll down to Home Menu Page 2 (there will be two interscreen navigation arrows, one at the top and one at the bottom of the screen). Press F3, which jumps to the Language Menu, and then use the NavPad to scroll to the user's native language.

3.8.10 Info

The Supply Information screen shows the date that the unit was last calibrated, Model Number and Serial Number of the unit, and version of the software. To access this screen, from Home Menu Page 2 press F4.



3.8.11 Remote

The Remote submenu allows setting of the GPIB address (when the option is installed) and the baud rate for the RS232C interface. To access, from Home Menu Page 3, press F1. Use the NavPad to set the GPIB address from 1 to 30, and the RS232C baud rate from 2400 to 19200. Pressing F1 will save the values in non-volatile memory so the values will be remembered after power down. Pressing F4 will keep the selected values only until the unit is powered down. The previously saved settings will be restored on power up.



If the unit is being controlled remotely via either the GPIB or RS232C interface, special screens may appear during operation. The following describes those displays:

- Remote Mode Primary display shows the actual values for Volts and Watts. F4 jumps to Home Timeout screen.
- Remote Mode Power display shows the set points on the first line, actual values for Voltage and Current on the second line, and at the bottom, the actual value for Watts with a bar graph of its percent of full-scale power. F4 jumps to the Constant Power screen.
- Remote Mode Sequence display shows what sequence is running. F4 jumps to the local Sequence Run screen.

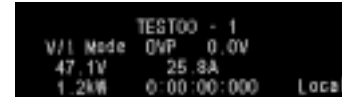
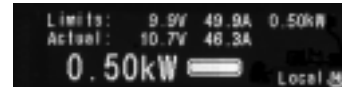

3.8.12 System

The System submenu allows the user to display the total system current when the unit is being paralleled with other SG series supplies.



From Home Menu Page 3, press F2 to enter the System Menu. Determine the Total System Current by adding the maximum current rating of all supplies in parallel. Use NavPad or the Keypad "0-9" to enter the appropriate value. F3 resets Total System Current to the supply default value; F4 keeps the displayed value and jumps to Home Menu Page 1.

3.8.13 Warning Screens

There are two warning screens that may appear during the course of operation:

Hard Fault warns that a hardware fault has occurred. This may be caused by an over-temperature condition, or a module fault occurring. These conditions may clear themselves, however, if they continue to occur after pressing the F4 (ClrFault) key, contact the factory for service assistance.

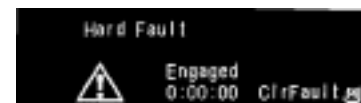

OVP Fault occurs when the output voltage of the supply exceeds the OVP setting. When this occurs the output is disabled, and voltage and current output go to 0. To clear the display, press F1 (Clr OVP). The display will return to Home Menu Page 1, and the output will remain disabled.



NOTE: It is important to correct the condition that caused the OVP, prior to enabling the output.

3.9 Basic Operation and Output Verification

The SGI Series power supply is shipped from the factory configured for local (Front Panel) Voltage/Current/Oversvoltage protection control and local voltage sensing. The ANALOG CONTROL connector is supplied with a mating connector with remote ON/OFF jumpered for ON (terminal 5 shorted to terminal 6).

At first time power up, the Voltage and Current are programmed to zero. The Overvoltage protection is set to maximum and the Output Condition status is **OFF**.

This section provides an overview and examples of front panel programming, Default Programming menu operation and initial functional tests for the SGI Series power supply.

3.9.1 Initial Setup



Before connecting the unit to an AC outlet, ensure that the front panel ON/OFF power switch is in the **OFF** position. Check the ANALOG CONTROL (J1) mating connector on the rear panel to verify that pins 5 and 6 (Remote Output On/Off) are shorted together. This is the default configuration installed from the factory. This jumper allows the output of the supply to be enabled from the front panel when the Output On/Off button is pressed. Apply power to the AC mains input.

3.9.2 Default Programming Menu

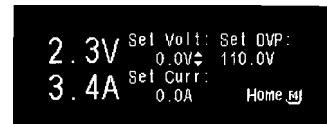
3.9.2.1 Voltage Mode Operation



In Voltage mode operation the output voltage is regulated at the selected value while the output current varies with the load requirements. To verify operation in voltage mode, follow the steps below:

- Connect a digital voltmeter (DVM) across the rear panel positive and negative output terminals, observing the correct polarity. Make sure the DVM is in the dc voltage mode and the range is adequate to handle the full-scale voltage of the power supply.
- Turn on the power supply. When the supply reaches the Home menu page 1, enable the output by pressing “Output On/Off.”
- Enter the Default Programming menu by pressing , , or  key.
- Program the Current to 10% of full-scale output (this sets the current limit at a nominal setting above 0 Amps and forces the supply into voltage mode). See Section 3.8.1 for more details on programming.
- Navigate to Voltage programming. With the Editing Arrow adjacent to “Set Volt”, press and hold the NavPad up arrow and observe both the front panel voltage display and the output of the DVM begin to accelerate up. The minimum range should be from 0V to the maximum rated voltage output of the supply. The front panel display and DVM readings should track within the accuracies of the meter and the front panel display.
- Verify the front panel Voltage Mode indicator is on.
- Program the Voltage and Current back to **zero**.
- Turn the power supply off.



If Voltage mode operation did not function as indicated above, recheck the setup and perform the check again. If the function continues to fail, contact the factory for assistance.

3.9.2.2 Current Mode Operation

In Current mode operation the output current is regulated at the selected value while the output Voltage varies with the load requirements. To verify operation in current mode, follow the steps below:



- Connect a high current DC ammeter across the rear panel positive and negative output terminals, observing the correct polarity. Select wire leads of sufficient current carrying capacity and an ammeter range compatible with the units maximum rated output current.

NOTE: If a high current ammeter is not available, simply short the output terminals together. This will not harm the supply.

- Turn on the power supply. When the supply reaches the Home menu page 1, enable the output by pressing “Output On/Off.”
- Enter the Default Programming menu by pressing , , or  key.
- Program the Voltage to 10% of full-scale output (this sets the Voltage limit at a nominal setting above 0 Volts and forces the supply into current mode). See Section 3.8.1 for more details on programming.
- Navigate to Current programming. With the Editing Arrow adjacent to “Set Curr”, press and hold the NavPad up arrow and observe both the front panel current display and the output of the DC ammeter begin to accelerate up. The minimum range should be from 0 Amps to the maximum rated current output of the supply. The front panel display and DC ammeter readings should track within the accuracies of the meter and the front panel display.
- Verify the front panel Current Mode indicator is on.
- Program the Voltage and Current back to **zero**.
- Turn the power supply off.
- Allow 5 minutes for the output capacitors to discharge and disconnect the ammeter or short from the output terminals.
- If Current mode operation did not function as indicated above, recheck the setup and perform the check again. If the function continues to fail, contact the factory for assistance.



3.9.2.3 Overvoltage Protection

The Overvoltage Protection (OVP) function allows the supply to shutdown the output when it exceeds a preset voltage limit. This may be used to protect sensitive circuits or loads from damage caused by an excessive voltage on the output of the supply. To verify OVP operation, follow the steps below:

- Make sure there is nothing connected across the output terminals.
- Turn on the power supply. When the supply reaches the Home Menu Page 1, enable the output by pressing “Output On/Off.”
- Enter the Default Programming menu by pressing , , or  key.
- Program the Current to 10% of full-scale output (this sets the current limit at a nominal setting above 0 Amps and forces the supply into voltage mode). See Section 3.8.1 for more details on programming.
- Navigate to OVP (Overvoltage) programming. The factory default setting is approximately 110% of the maximum rated output of the supply. With the Editing Arrow adjacent to “Set OVP”, press and hold the NavPad **down** arrow and observe the front panel voltage display accelerate down. Release the NavPad **down** arrow when the OVP is programmed to about 80-90% of the maximum rated output voltage value.

- Navigate to Voltage programming. With the Editing Arrow adjacent to “Set Volt”, press and hold the NavPad **up** arrow and observe the front panel voltage display accelerate up. When the output voltage exceeds the OVP trip point the OVP Warning screen will be display with the voltage level reached at OVP trip. The Output Condition will be programmed to **OFF**, and the voltage, current, and OVP settings will retain their previous settings.



- Press (F4) and the fault screen will clear after 4 seconds. The Home Menu Page 1 will be displayed, and the output will remain disabled.
- Enter the Default Programming menu by pressing , , or  key.
- Program the OVP setting as appropriate for the application as shown above. If OVP will not be used, then “OVP set” programming may be set at maximum, approximately 110% of the rated output voltage of the supply.

If OVP mode did not function as indicated above, recheck the setup and perform the check again. If the function continues to fail, contact the factory for assistance.

3.9.3 Remote Analog Control

The Analog Control connector on the rear panel allows the unit to be configured for different operating configurations: local and remote current programming, local and remote voltage programming, current and voltage output monitoring, output enable/disable, etc. The setup and operating requirements of each configuration are provided in this section.

The SGI also has the capability of providing summing of remote analog input with the set values on the front panel (or programmed values via the digital interface) for voltage, current and OVP. This capability provides a means to modulate a set value with the signal on the voltage, current and OVP analog input. If the user only desires to control the unit with the analog input, all the front panel values (V/I/OVP) or digital settings should be set to zero.

3.9.3.1 Isolated Analog Control (Option)

The Isolated Analog Control uses the same Analog Control connector (J1). This option fully isolates remote control signals and allows control of units not connected to a common ground. Control ground is isolated from power ground, which protects against potential damage from systems with high electrical noise or large ground loop currents.

Note: Some standard analog programming signals may not be available with this option. See Table 1.2.2, Electrical Characteristics, for details.



CAUTION!

This option is not intended to allow operation of the power supply at excessive voltages. Refer to Section 2 INSTALLATION for maximum terminal voltages.

Following are Figure 3–5 with the connector's pin-out diagram, and Table 3–1 with Analog Control connector designations and functions:

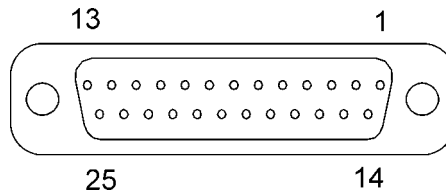

Figure 3-5. Analog Control Connector (J1) Pin-out

| Designator | Schematic Symbol | Electrical Chars. | Functional Description |
|------------|------------------|--------------------------|--|
| 1 | ISO ON/OFF | Z _{in} ~ 6 kΩ | Isolated remote on/off. Externally supplied AC/DC voltage source for on/off control. A positive (+) 12 to 240 VAC or 6 to 120 VDC voltage will turn on the supply. This input control is optically isolated from the power supply circuit up to 500 VDC. See Section 3.13. |
| 2 | ISO RTN | — | Isolated circuit return used with isolated on/off control J1-1 and J1-14. |
| 3 | REM OV SET | Z _{in} ~ 20 kΩ | Remote overvoltage set. A remote signal sets the over-voltage trip level. 0-5.5 VDC = 0-110%. Apply a 10.5 VDC to 13.3 VDC signal for 4 seconds to reset an OVP condition. See Section 3.14. |
| 4 | VP RTN | Z _{in} ~ 10 kΩ | Voltage programming return. Used with J1-9, J1-15 or J1-21 and must be referenced to or within ±3V of the circuit common. |
| 5 | ON/OFF | Must sink ~1mA to enable | Remote on/off. Switch/relay contacts or a direct short between this terminal and circuit common turns on the unit. |
| 6 | COM † | - | Circuit common. Same potential as the negative output terminal. |
| 7 | I MON | Z _{out} ~ 100Ω | Output current monitor. 0-10 VDC equals 0-100% rated current. Minimum load resistance 10kΩ. |
| 8 | V SET * | Z _{out} ~ 100Ω | 0-5 VDC (0-100%) front panel voltage control monitor output. Minimum load resistance 10kΩ. |
| 9 | VP 5V | Z _{in} ~ 10kΩ | Remote voltage programming using a 0-5 VDC source. Do not exceed 13.3 VDC. |
| 10 | IP 5V | Z _{in} ~ 10kΩ | Remote current programming using a 0-5 VDC source. Do not exceed 13.3 VDC. |

| Designator | Schematic Symbol | Electrical Chars. | Functional Description |
|------------|------------------|------------------------------------|--|
| 11 | ISET * | Zout ~ 100Ω | 0-5 VDC (0-100%) front panel current control monitor output. Minimum load resistance 10kΩ. |
| 12 | SENSE - | ~ 1000Ω to neg (-) output terminal | Remote Sense (-) on 60 volts output units. (For new installations, use J3, recommended only for backward compatibility in existing systems.) |
| 13 | SENSE + | ~ 1000Ω to pos (+) output terminal | Remote Sense (+) on <60 volts output units. (For new installations, use J3, recommended only for backward compatibility in existing systems.) |
| 14 | ISO TTL/CMOS | Zin ~ 2.2kΩ | Isolated TTL/CMOS on/off control. A high state TTL/CMOS voltage turns on the power supply, and a low state or open connection turns the supply off. |
| 15 | VP 10V | Zin ~ 20kΩ | Remote voltage programming using a 0-10 VDC source. Do not exceed 25 VDC. |
| 16 | IP 10V | Zin ~ 20kΩ | Remote current programming using a 0-10 VDC source. Do not exceed 25 VDC. |
| 17 | FAULT | Zout ~ 100Ω | Fault state output. A high state (approximately +10 VDC) indicates a converter, temperature or bias supply fault, and the LED on the front panel will illuminate. |
| 18 | S/D FAULT | Zout ~ 100Ω | Shutdown fault. This terminal goes to high state in the event of converter, temperature, overvoltage or bias supply fault. A 7 VDC to 13.3 VDC signal can be applied to this pin to shutdown the output of the unit. An 8 VDC minimum output signal is provided into a 10 kΩ minimum load, in the event of an internally generated shutdown. |
| 19 | V MON | Zout ~ 100Ω | Output voltage monitor. 0-10 VDC equals to 0-100% rated voltage. Minimum load resistance 10kΩ. |
| 20 | VP RTN | Zin ~ 10Ω | Voltage programming return. Used with J1-9, J1-15 or J1-21 and must be referenced to or within ±3V of the circuit common. |
| 21 | VP RES * | ~ 10.8V compliance | 1 milliamp current source for remote voltage programming using resistance. 0-5k ohm resistor referenced to common will program the output voltage from 0-100%. |
| 22 | IP RES * | ~ 10.8V compliance | 1 milliamp current source for remote current programming using resistance. 0-5k ohm resistor referenced to common will program the output from 0-100%. |

| Designator | Schematic Symbol | Electrical Chars. | Functional Description |
|------------|------------------|------------------------|---|
| 23 | IP RTN | Z _{in} ~ 10kΩ | Current programming return. Used with J1-10, J1-16 or J1-22 and must be referenced to or within ±3V of the circuit common. |
| 24 | COM † | - | Circuit common. Same potential as the negative output terminal. |
| 25 | IP RTN | Z _{in} ~ 10kΩ | Current programming return. Used with J1-10, J1-16 or J1-22 for remote current programming and must be referenced to or within ±3V of the circuit common. |

Table 3–1 Analog Control Connector (J1), Designations and Functions

† Control ground is isolated from power ground with the isolated analog control (option). See Section 3.9.3.1

* Signals not available with isolated analog control (option).



CAUTION!

If standard analog programming is used, note the programming return (J1-6 & J1-24) is at the same potential as the negative output terminal of the power supply. Observance of return connections should be made with respect to input programming signal equipment. Improper connection may result in ground loops and as a result internal power supply damage may occur. (Output current then flows to chassis by means of external connection to the J1 common (J1-6 & J1-24)).

3.10 Remote Current Programming

Remote current programming is summed with the front panel or digital setting (see Section 3.9.3). Remote current programming is used for applications that require the output current be programmed (controlled) from a remote source. An external resistance or external voltage source may be used as a programming device. When using remote current programming, a shielded, twisted-pair, hookup wire is recommended to prevent noise interference with programming signals.

1. Remote Current Programming Using Resistance:

The resistance coefficient for remote current programming is 5k ohms/100% rated output with respect to terminal J1-23 (IP RTN). The programming current from terminal J1-22 (IP RES) is factory set for 1 milliampere. This yields a coefficient of 1.0% of rated output current for each 50 ohms. If multiple switches or relays are used to program different levels, make-before-break contacts are recommended. Note that if an external resistance is used for remote programming, the current programming return (IP RTN), terminal J1-23, must be connected directly to or within ± 3 volts (see note) of the power supply common terminal, J1-24. See Figure 3-6 for connection requirements.

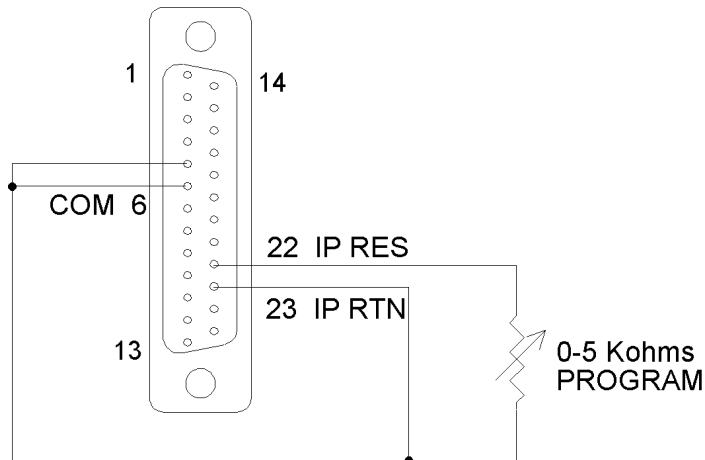

Figure 3-6 Remote Current Programming Using Resistance

2. Remote Current Programming Using a 0-5 VDC or 0-10 VDC Voltage Source:

A DC voltage source for remote current programming is connected between J1-10 (IP 5V) or J1-16 (IP 10V) and the return terminal J1-23 (IP RTN). Note that the return terminal J1-23 (IP RTN) must be referenced directly to or within ± 3 V (see note) of the power supply common, J1-24. The voltage coefficient for 5V remote current programming is 50 millivolts = 1% of rated output, i.e., for a 300 amp model, each 50 millivolts of programming voltage equals 3 amps of output current. The voltage coefficient for 10V remote current programming is 100 millivolts = 1% of rated output, i.e., for a 300 amp model, each 100 millivolts of programming voltage equals 3 amps of output current. See Figure 3-7 for connection requirements.

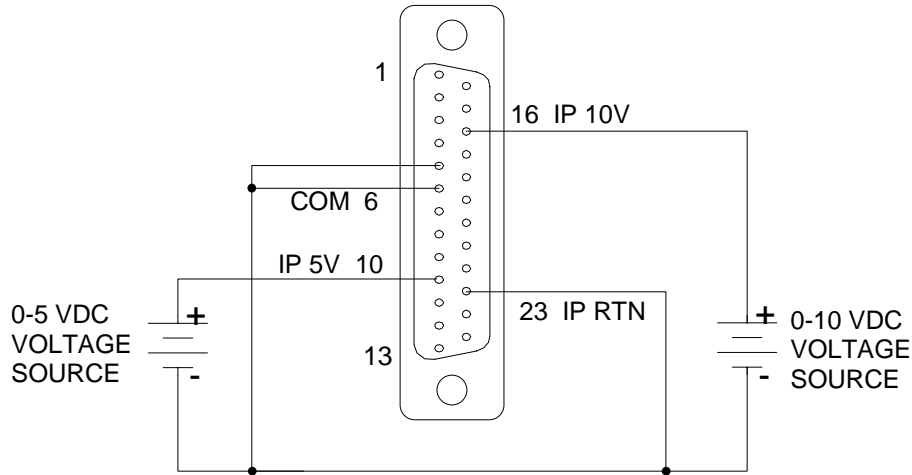

Figure 3–7 Remote Current Programming Using 0-5 VDC or 0-10 VDC Voltage Source

3.11 Remote Voltage Programming

Prior to conducting this programming, set Front Panel Current to Zero. Remote voltage programming configuration is used for applications that require the output voltage be programmed (controlled) from a remote source. An external resistance or external voltage source may be used as a programming device. When using remote voltage programming, a shielded, twisted-pair, hookup wire is recommended to prevent noise interference with programming signals.

- External Voltage Programming Using Resistance:**
 The resistance coefficient for remote voltage programming is 5k ohms/100% of rated output voltage with respect to the VP RTN, J1-20. The programming current from terminal J1-21 (VP-RES) is factory set to 1 milliampere. This yields a coefficient of 1.0% of rated output voltage for each 50 ohms. If multiple switches or relays are used to program different levels, make-before-break contacts are recommended. Note that if an external resistance is used for remote programming, the voltage programming return (VP RTN), terminal J1-20, must be connected directly to or within ± 3 volts (see note) of the power supply common terminal, J1-24 See Figure 3–8 for connection requirements.

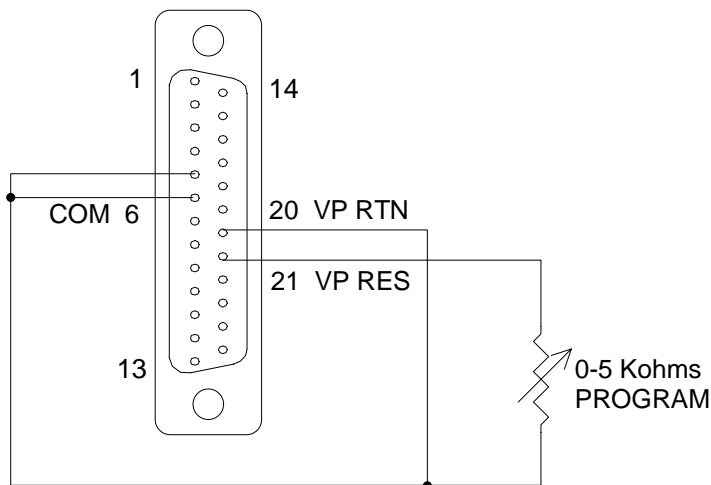

Figure 3–8 Remote Voltage Programming Using Resistance

2. External Voltage Programming Using a 0-5 VDC or 0-10 VDC Voltage Source:
 A DC voltage source for remote voltage programming is connected between J1-9 (VP 5V) or J1-15 (VP 10V) and the return terminal J1-20 (VP RTN). Note that the return terminal (VP RTN) must be referenced directly to or within $\pm 3V$ (see note) of the power supply common, J1-24. The voltage coefficient for 5V remote voltage programming is 5 volts = 100% of rated output voltage. The voltage coefficient for 10V remote voltage programming is 10 volts = 100% of rated output voltage. See Figure 3–9 for connection requirements.

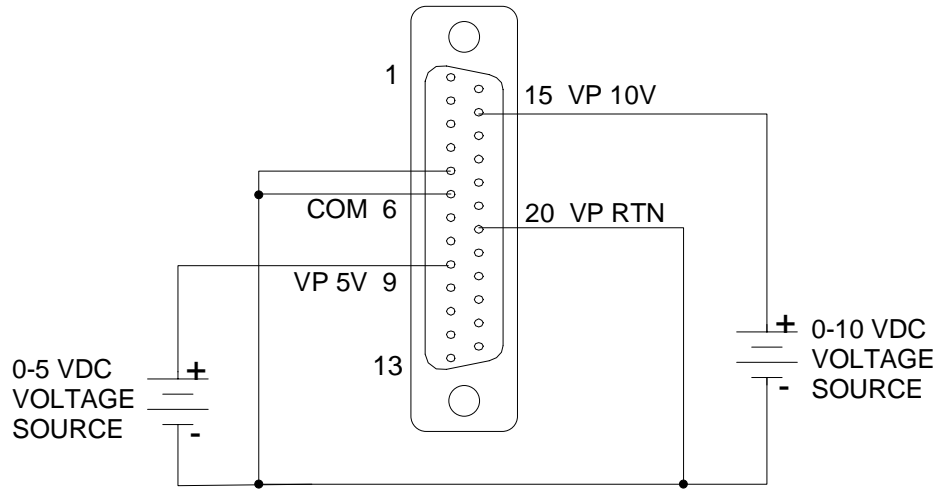



Figure 3–9 Remote Voltage Programming Using 0-5 VDC or 0-10 VDC Voltage Source

3.12 Remote Sensing

Remote voltage sensing is recommended at all times, whether the sensing leads are connected to the load or directly to the output terminals. Remote sensing at the load provides the best load regulation.

In applications where the load is located some distance from the power supply, or the voltage drop of the power output leads significantly interferes with load regulation, remote voltage sensing should definitely be used.

| | |
|---|---|
|  | <p>CAUTION! Although damage will not occur, it is NOT recommended to operate with load power lines disconnected and sensing line connected.</p> |
|---|---|

To use remote voltage sensing, connect the power supply as described below. See Figure 3–10 for connection requirements.

Connect sensing leads from the load positive to J3-1 and the load negative to J3-2. A shielded, twisted-pair, hookup wire is recommended to avoid potential noise interference.

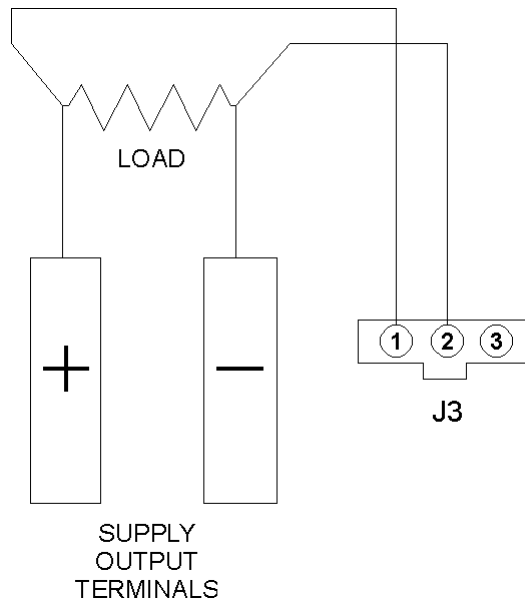

Figure 3–10 Remote Sensing Operation at the Load

3.13 Remote Output On/Off Control

Remote on/off control may be accomplished by contact closure or by an isolated external AC/DC or TTL/CMOS voltage source.

1. Remote on/off by contact closure. Output is on when contacts (J1-5 and J1-6) are closed. See Figure 3–11 for connection requirements.

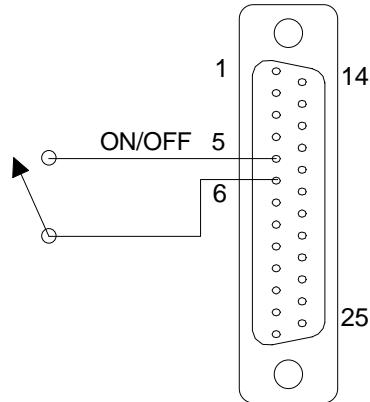

Figure 3–11 Remote On/Off Control by Contact Closure

2. Remote on/off control may be accomplished by an external 12 to 240 VAC or 6 to 120 VDC or TTL/CMOS source. Application of AC/DC or high state TTL/CMOS voltage will turn on the power supply. See Figure 3–12 and Figure 3–13 for connection requirements.

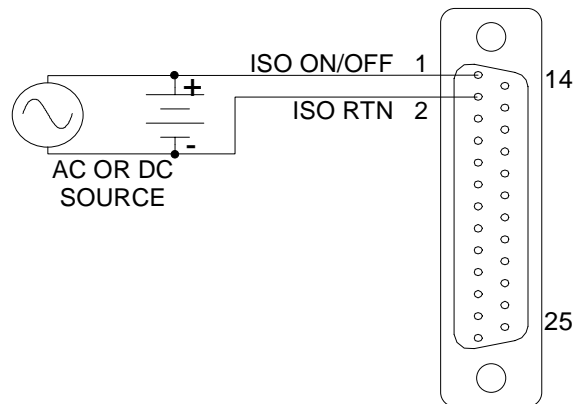

Figure 3–12 Remote On/Off Using Isolated AC or DC Voltage Source

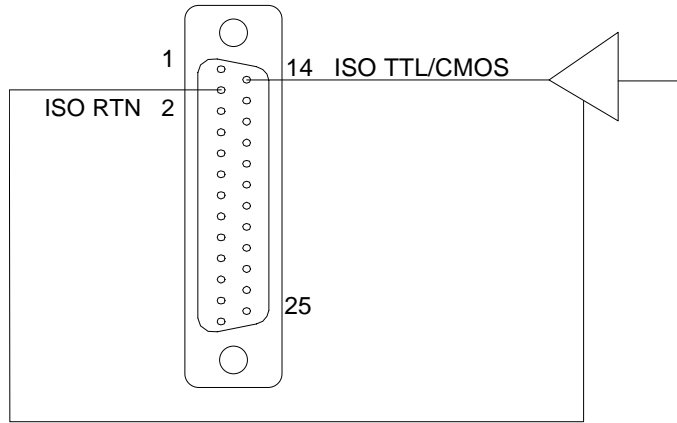

Figure 3–13 Remote On/Off Using Isolated TTL/CMOS Voltage Supply

3.14 Remote Overvoltage Setpoint



CAUTION!

Do not program the remote overvoltage set point greater than 10% (5.5V) above the power supply rated voltage (except as noted) as internal power supply damage may occur.

Remote OVP programming is summed with the front panel or digital setting (see Section 3.9.3). A remote DC voltage source can be connected externally between terminals J1-6 (COM) and J1-3 (REM OV SET) to set the output overvoltage trip level. A 0-5.5 VDC signal equals 0-110% of rated output voltage. See Figure 3–14 for connection requirements.

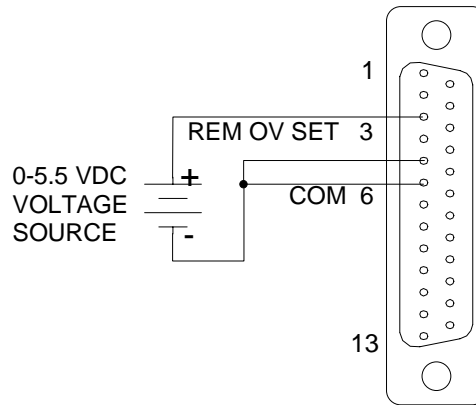

Figure 3–14 Remote Overvoltage Set Using DC Voltage Source

Note: To reset an OVP externally, apply a 10.5–13.3 VDC signal to J1-3 for a minimum of four (4) seconds.

3.15 Remote Shutdown (S/D)

A remote +12 VDC voltage can be connected externally between terminals J1-18 (S/D Fault) and J1-24 (COM) to disable, i.e., shut down the output of the power supply. Disabling or opening the +12 VDC signal will allow the unit to revert to normal operation.

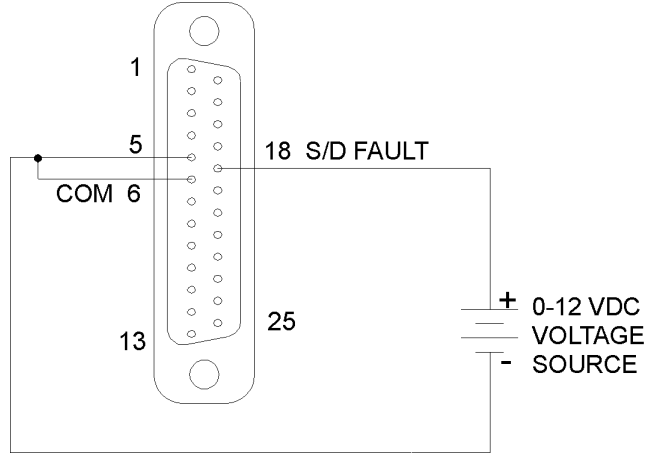

Figure 3–15 Remote Shutdown Using DC Voltage Source

3.16 Master/Slave Operation

The following modes of operation are used for applications requiring more current or voltage than is available from a single power supply. To meet the requirements for greater output voltage or current, two supplies may be connected in series or up to five connected in parallel.

3.16.1 Parallel Operation

In the parallel mode of operation, a master/slave configuration is established. Up to five power supplies may be paralleled using this configuration. To set up the parallel mode of operation, connect the interface cable (Elgar P/N 890-453-03) from the master unit parallel out to the Slave 1 unit (located at Power Supply #2 location in Figure 3–16 below), and from remaining slaves parallel out to parallel in, as shown below in Figure 3–16. Next connect the positive outputs of supplies together and the negative outputs of the supplies together. It is recommended that the outputs are connected together as close to the load as practical. (See Section 3.8.12 for displaying Total System Current).

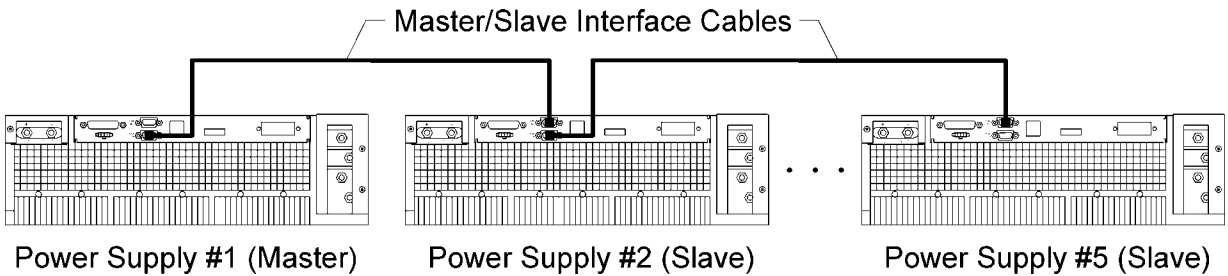

Figure 3–16 Master/Slave Connection

Note: *The OVP circuit remains active for all units in parallel operation. If the units are set to different OVP levels, the paralleled system will trip according to the lowest setting. For ease of use, adjust the OVP levels for the slaves to maximum and adjust the master OVP level to the desired setting.*

3.16.2 Series Operation

Series operation is used to obtain a higher voltage single output supply using two units. Connect the negative terminal (–) of one supply to the positive terminal (+) of the next supply of the same model. The total voltage available is the sum of the maximum voltages of each supply (add voltmeter readings).

Notes:

1. Under no condition should the negative (–) output terminal of **any** power supply exceed 150V to Earth ground. This is limited by the creepage/clearance distances internal to the construction of the metal shell 25-pin 'D' connector mated to J3. If a higher output voltage range is required, contact the Sorensen Sales Department or Customer Service for availability.
2. The maximum allowable current for a series string of power supplies is the rated output current of a single supply in the string.
3. Remote sensing should **not** be used during series operation.

SECTION 4

VERIFICATION AND CALIBRATION

4.1 Introduction

This section provides verification and calibration procedures for the standard SGI Series power supplies and isolated analog control (option) analog section. Please refer to the SG Programming Manual for calibration of display readback and remote digital programming DIA option.

4.1.1 Verification and Calibration Cycle

It is recommended that the power supply be calibrated and/or verified once each year of operation.

4.1.2 Preparation



WARNING!

Hazardous voltages exist on the rear of the supply. Great care must be taken to avoid both the input terminals, and while the supply is enabled, the output terminals. Only authorized personnel should perform this procedure.

Due to the importance of accurate readings to performance, only technically trained personnel should perform calibration procedures.

The calibration and adjustment procedures require two digital multimeters. To set up for the calibration procedures, first perform the following:

- Remove prime AC power.
- Connect the power supply to a precision current shunt (as shown in Figure 4–1 below) capable of a minimum of 10% above full rated output. A fan may be required to cool the shunt.

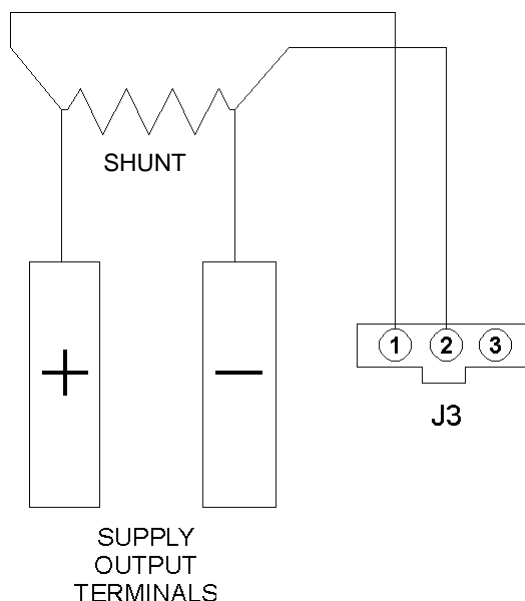

Figure 4–1 Precision Current Shunt

4.2 Standard Verification and Calibration Procedure

All calibration potentiometers can be adjusted through access holes in the top cover of the SGI Series unit. It is **not** necessary to remove the top cover to perform the calibration procedure. When the unit is configured for the Isolation Option, calibration of this board must be done first (go to Section 4.3).

4.2.1 Current Mode

1. Set the SGI Series unit to operate in remote current programming mode using an external 0-5 Vdc voltage source as shown in Figure 3–7 in Section 3.3 Remote Current Programming.
2. Attach a precision meter across the shunt Kelvin terminals.
3. Attach a precision meter in parallel with the voltage programming source.
4. Set the voltage source to $0.0V \pm 1mV$.
5. Apply AC power and press the "Output On/Off" button (see Section 3.2.1, Front Panel Controls and Indicators).
6. Set the programming voltage to $5.0V \pm 1mV$.
7. Verify the unit is set to $100\% \pm 0.8\%$ of full-scale output current. If necessary, adjust R69 for 100% of full-scale current on the shunt.
8. Set the programming source for $0.5V \pm 1mV$.

9. Verify the unit is set to $10\% \pm 0.8\%$ of full-scale output current. If necessary, adjust R55 for 10% of full-scale current on the shunt.
10. Repeat the steps above as required to obtain the required accuracy.

4.2.2 Voltage Mode

1. Disable AC power to the unit. Remove the current shunt from the output and verify that there is no load attached.
2. Remove the precision meter leads from the current shunt and apply them across the output terminals.
3. Set the SGI series unit to operate in remote voltage programming mode using an external 0-5 Vdc voltage source as shown in Figure 3–9 in Section 3.4 Remote Voltage Programming.
4. Apply AC power and press "Output On" button (see Section 3.2.1, Front Panel Controls and Indicators).
5. Set the programming source to $5.0V \pm 1mV$.
6. Verify that the unit is set to $100\% \pm 0.25\%$ of full-scale output voltage. If necessary adjust R74 for 100% output voltage.
7. Set the programming source to $0.5V \pm 1mV$.
8. Verify that the unit is set to $10\% \pm 0.25\%$ of full-scale output voltage. If necessary adjust R90 for 10% output voltage.
9. Remove all connections to the remote analog control connector (J1). Place the jumper between pins 5 and 6. This reverts the SGI series unit back to local, front panel control.
10. Repeat the steps above as required to obtain the required accuracy.

**CAUTION!**

Hazardous voltages may be present on the output after the output is disabled due to stored capacitive charge. Allow 5 minutes to drain the output capacitive charge to safe levels before connecting or removing output wiring.

4.2.3 Resistor Programming Current Sources

(Only for units without Isolated Analog Option)

1. Disable AC power to the unit.
2. Connect the power supply to a precision current shunt (see Figure 4–1, Section 4.1.2 Preparation).
3. Set the SGI series unit to operate in remote current programming mode using resistance by connecting a 5K ohm (1% or better tolerance) resistor as shown in Figure 3–6 in Section 3.10 Remote Current Programming.
4. Attach a precision meter across the shunt Kelvin terminals.
5. Apply AC power and press Output On button (see Section 3.2.1, Front Panel Controls).
6. Adjust R71 to measure 100% Current Output.
7. Disable AC power to the unit.
8. Set the SGI series unit to operate in remote voltage programming mode using resistance by connecting a 5K ohm (1% or better tolerance) resistor as shown in Figure 3–8 in Section 3.11 Remote Voltage Programming.
9. Apply AC power and enable the unit via the front panel On/Off switch.
10. Adjust R45 to measure 100% Output Voltage.
11. Disable AC power and remove all connections to the remote analog control connector (J1), except the jumper between pins 5 and 6.

4.3 Isolated Analog (Option) Verification and Calibration Procedure

All calibration potentiometers can be adjusted through access holes in the top cover of the SGI Series unit. It is **not** necessary to remove the top cover to perform the calibration procedures.

4.3.1 Current Mode

1. Set the SGI series unit to operate in remote current programming mode using an external 0-5 Vdc voltage source as shown in Figure 3–7 in Section 3.10 Remote Current Programming.
2. Connect a precision shunt as shown in Figure 4–1.
3. Attach a precision meter across the shunt Kelvin terminals.
4. Attach a precision meter in parallel with the voltage programming source.
5. Set the voltage source to $0.0V \pm 1mV$.
6. Apply AC power and program the voltage to 100% of rated output voltage. Enable the output.
7. Set the programming voltage to $5.0V \pm 1mV$.
8. Verify that the unit is set to $100\% \pm 0.8\%$ of full scale output current. If necessary, adjust R33 for 100% of full scale current on the shunt.
9. Set the programming source for $0.5V \pm 1mV$.
10. Verify that the unit is set to $10\% \pm 0.8\%$ of full scale output current. If necessary, adjust R47 for 10% of full scale current on the shunt.
11. Repeat the steps above as needed to obtain the required accuracy.

4.3.2 Voltage Mode

1. Disable AC power to the unit. Remove the current shunt from the output and verify that there is no load attached.
2. Remove the precision meter leads from the current shunt and apply them across the output terminals.
3. Set the SGI series unit to operate in remote voltage programming mode using an external 0-5 Vdc voltage source as shown in Figure 3–9 in Section 3.11 Remote Voltage Programming.
4. Apply AC power and program the current to 100% of rated output current. Enable the output.

5. Verify that the unit is set to $0V \pm 0.25\%$ of full-scale output voltage. If necessary adjust R35 to obtain zero output volts. (See Figure 4-2.)
6. Set the programming voltage to $5.0V \pm 1mV$.
7. Verify that the unit is set to $100\% \pm 0.25\%$ of full-scale output voltage. If necessary adjust R39 for 100% output voltage.
8. Set the programming source to $0.5V \pm 1mV$.
9. Verify that the unit is set to $10\% \pm 0.25\%$ of full-scale output voltage. If necessary adjust R35 for 10% output voltage.
10. Repeat the steps above as needed to obtain the required accuracy.
11. Remove all connections to the remote analog control connector (J1), except the jumper between pins 5 and 6. This reverts the supply back to local, front panel control.

**CAUTION!**

Hazardous voltages may be present on the output after the output is disabled due to stored capacitive charge. Allow 5 minutes to drain the output capacitive charge to safe levels before connecting or removing output wiring.

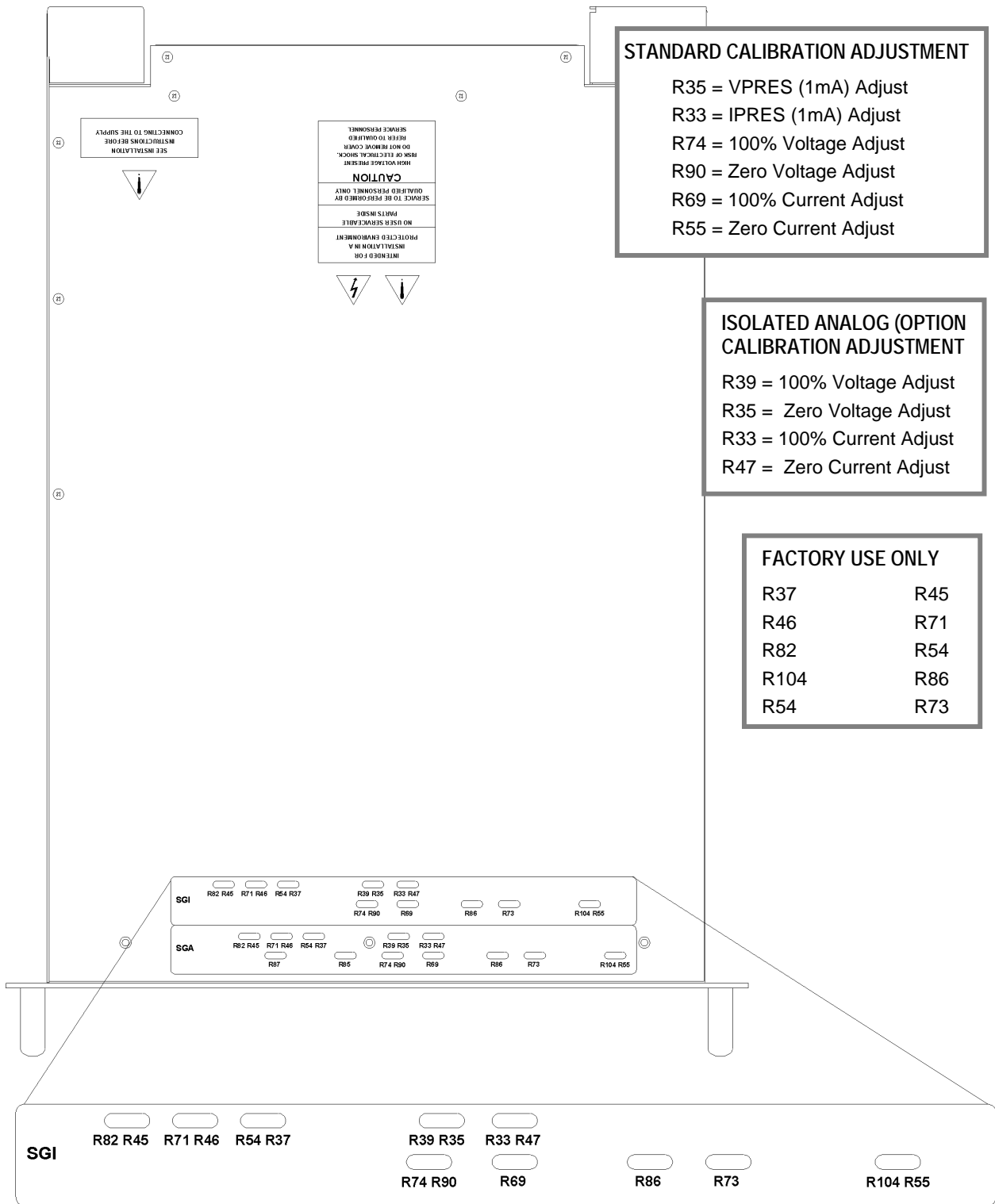

Figure 4-2 Potentiometer Locations

SECTION 5 MAINTENANCE

5.1 Introduction

This chapter contains preventive maintenance information for the SGI Series power supplies.



WARNING!

All maintenance that requires removal of the cover of the unit should only be done by properly trained and qualified personnel. Hazardous voltages exist inside the unit. Disconnect the supply from the input power before performing any maintenance. Service, fuse verification, and connection of wiring to the chassis must be accomplished at least *five minutes* after power has been removed via external means; all circuits and/or terminals to be touched must be safety grounded to the chassis.

5.2 Preventive Maintenance

No routine maintenance on the SGI Series is required, aside from periodic cleaning of the unit when needed:

- Once a unit is removed from service, vacuum all air vents, including the front panel grill. Clean the exterior with a mild solution of detergent and water. Apply the solution onto a soft cloth, not directly to the surface of the unit. To prevent damage to materials, do not use aromatic hydrocarbons or chlorinated solvents for cleaning.
- Low-pressure compressed air may be used to remove dust from in and around components on the printed circuit boards.



WARNING!

The OFF position of the power switch does not remove voltage from the input terminal blocks. Remove all external power before performing any service.

An annual inspection of the SGI Series unit is recommended. Table 5-1 lists the visual inspection checks to be performed, and the corrective action to be taken.

| Item | Inspect For | Corrective Action |
|--------------------------------------|--|---|
| External connector plugs and jacks | Looseness, bent or corroded contacts, damage or improper seating in mating connector | Clean contacts with solvent moistened cloth, soft bristle brush, small vacuum, or low compressed air. |
| | | Replace connectors damaged, deeply corroded, or improperly seated in mating connector. |
| Chassis, fan, and extruded heatsinks | Dirt and corrosion | Clean with cloth moistened with soapy water. |
| External electrical wiring | Broken, burned or pinched wire; frayed, worn or missing insulation | Repair or replace defective wires. |
| External solder connections | Corrosion, loose, cracked, or dirty connections | Clean and resolder connections. |
| Dirt and moisture buildup | Short circuits, arcing, corrosion, overheating | Clean as required. |
| Front panel controls and meters | Dirt and corrosion | Clean with cloth moistened with soapy water. |
| | | Use a Kimwipe tissue and GTC glass-cleaning compound to clean the meter faces. |

Table 5-1 Recommended Annual Inspection



CAUTION!

For safe and continued operation of the SGI Series, always operate the unit in a temperature and humidity controlled, indoor area, free of conductive contaminants. Remember to keep the rear and sides of the unit free of obstructions to ensure proper ventilation.

5.3 Fuses

There are no user replaceable components in the power supply.



WARNING!

Only properly trained and qualified personnel should remove the cover from the power supply. Service, fuse verification, and connection of wiring to the chassis must be accomplished at least *five minutes* after power has been removed via external means; all circuits and/or terminals to be touched must be safety grounded to the chassis.



CAUTION!

To reduce the risk of fire or electrical shock, replace fuses only with the same type and rating.

Internal fuses are listed in Table 5–2. Note, however, that failure of one of these fuses indicates a more serious problem has occurred. Please contact the factory for further assistance.

| PCB Part No. | Reference | Value | Manufacturer Part No. |
|---------------------------|------------|------------------|-----------------------|
| Bias Supply 5546335 | F1, F2, F3 | 600 Volt, 5 Amp | Littelfuse KLK-5 |
| Module Controller 5556210 | F1 | 600 Volt, 30 Amp | Littelfuse KLKD30 |

Table 5–2 Fuse Values

INDEX

- A
 - Aborting an edit, **3-7**
- B
 - Basic Sequence Operation, **3-13**
- C
 - Calibration
 - Date Last Calibrated, 3-4
 - Calibration and Verification, 4-1
 - Circuit Breaker Requirements, 2-2
 - Controls and Indicators, 3-1
 - Analog Control (J1), 3-24
 - Current Mode
 - Operation, 3-22
 - Verification and Calibration, 4-2
- D
 - Default Programming, 3-22
 - Display Brightness, 3-19
 - Display Elements, 3-4
- E
 - Editing, 3-6
- F
 - Front Panel, 3-1
 - Functions, 3-11
 - Fuses, 5-3
- H
 - Home Menu, 3-8
 - Home Timeout, 3-19
- I
 - Inductive Loads, 2-7
 - Input/Output Connections, 2-2
 - Connector Functions, 2-3
 - Isolated Analog Control, 3-24
- J
 - J1 Connector, 3-24
- L
 - Language, 3-20
 - Last Cal Date, 3-4
 - Loads
 - Inductive, 2-7
 - Location and Mounting, 2-2
 - Lock Key, 3-20
- M
 - Maintenance
 - Annual Inspection, 5-2
 - Fuses, 5-3
 - Preventive, 5-1
 - Master/Slave Operation, 3-34
 - Menu Map, 3-8
 - Mounting Hardware, 2-2
- N
 - Navigation, 3-5

Noise, 1-4

O

Operation

Current Mode, 3-22

Local, 3-21

Master/Slave, 3-34

Parallel, 3-34

Remote Current Programming, 3-28

Remote Output On/Off Control, 3-32

Remote Overvoltage Setpoint, 3-33

Remote Sensing, 3-31

Remote Shutdown, 3-34

Remote Voltage Programming, 3-29

Series, 3-35

Voltage Mode, 3-22

Operations, Step, 3-14

Overvoltage Protection, 3-23

Ozone Precaution, 2-2

P

Parallel Operation, 3-34

Potentiometer Locations, 4-7

Power Mode, 3-19

Programming Current, 3-11

Programming Overvoltage, 3-11

Programming V/I/P, 3-11

Programming Voltage, 3-11

R

Rack slides, 2-2

Rear Panel, 3-3

Recall, 3-12

Remote Current Programming, 3-28

Remote Mode, 3-20

Remote Output On/Off Control, 3-32

Remote Overvoltage Setpoint, 3-33

Remote Sensing, 3-31

Remote Shutdown, 3-34

Remote Voltage Programming, 3-29

Ripple, 1-4

S

Safety Symbols, iv

Save V/I/OVP Settings, 3-11

Saving to Power ON, 3-12

Screens

Other screens, 3-10

Warning, 3-10

Sequencing, 3-12

Sequencing Examples, 3-16

Series Operation, 3-35

Setup, 3-22

SGI Initial Start-up, 3-4

Single Step, 3-13

Specifications, 1-1

Current, 1-4

Electrical Characteristics, 1-2

Environmental Characteristics, 1-1

Noise, 1-4

Physical Characteristics, 1-4

Ripple, 1-4

Voltage, 1-4

Step Operations, 3-14

Supply Info, 3-20

T

Total System Current, 3-21

V

Ventilation, 2-2

Verification and Calibration, 4-2

Current Mode, 4-2

Isolated Analog (Option), 4-5

Voltage Mode

Operation, 3-22

W

Warning Screens, 3-21

Wire Gauge Selection, 2-5

Wire Size, 2-4