

TCR Series DC Power Supplies



**ELECTRONIC
MEASUREMENTS,
INC.**



2U 600 watt 1000 watt 3-1/2" Panel

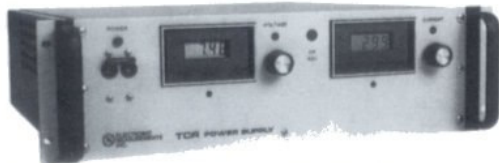

3U 1800 watt 5-1/4" Panel



4U 2800 watt 7" Panel



4U 2.5 KW 7" Panel



5U 5 KW 8-3/4" Panel

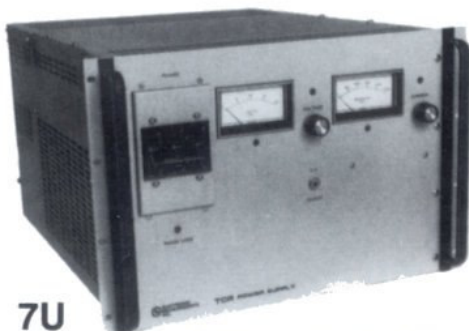

7U 10 KW 12-1/4" Panel

MAJOR FEATURES

- Combine optimum performance and reliability.
- Highest power-per-cubic-inch in industry.
- Reduction in line-conducted RFI by 1000 times over previous SCR models. (Complies with VDE 875 Level N and VDE 871 Level A.)
- High dielectric withstand ratings primary to secondary and chassis (2500 V rms).
- Low output ripple and high operating efficiency.
- Input, output and programming terminals covered for operator protection.
- Series or parallel master/slave operation.
- Common programming with E/M's three-phase TCR models and its EMHP and HCR Series.
- Five-year warranty.

APPLICATIONS

- Semiconductor aging racks
- CW lasers
- General industrial DC power
- Capacitor forming
- Focusing coils for accelerators
- Cryogenic magnet applications
- Electroplating
- Battery charging
- ARC lamp power supplies
- DC motor drive supplies

FIVE-YEAR WARRANTY

Electronic Measurements, Inc. warrants this equipment manufactured by us and sold by us or our authorized agents to a manufacturer or end user to be free from defects in material or workmanship. Our liability under this warranty is limited to servicing and repair or replacement of parts when equipment is returned to us with transportation charges prepaid within a period of five years after original shipment and when the equipment is shown by our inspection to be thus defective, normal wear and tear excepted.

This warranty does not apply to equipment subjected to abuse or incorrect installation or operation, nor to equipment repaired or modified outside of the Electronic Measurements, Inc. factory unless prior written approval to make such repairs or modifications has been received from the factory. The foregoing warranty is in lieu of all other express or implied warranties except of title.

Theory of Operation

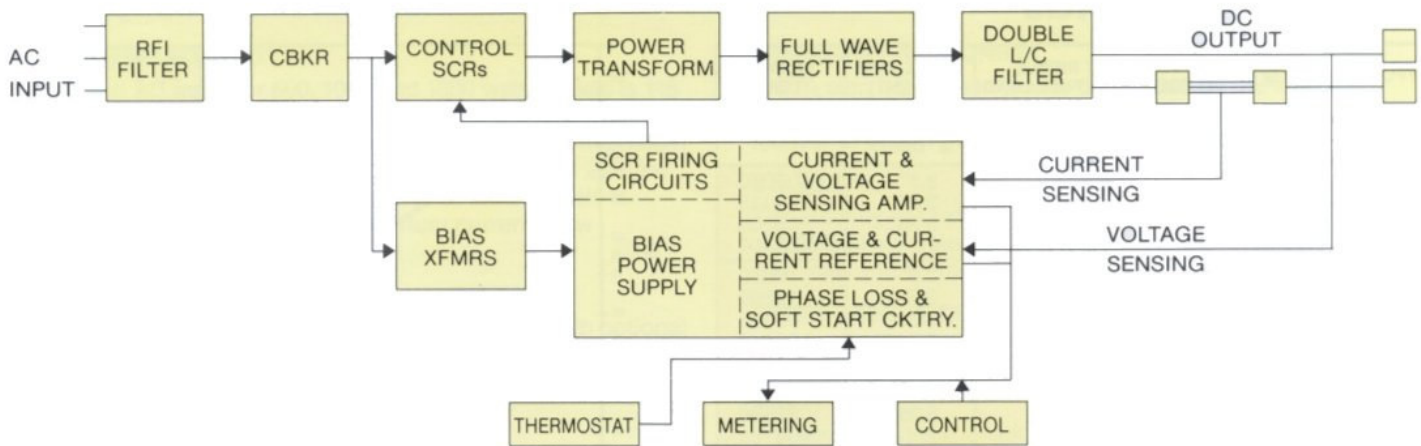

In an SCR phase-controlled DC Power Supply, output is controlled by modulating the conduction angle of the controlling SCRs. In the TCR Series, input AC is applied to three pair of bi-directionally connected SCRs placed within the delta connected primary of the main power transformer. The secondary voltage of this transformer is rectified and double L/C filtered to provide a low ripple DC output. Both

output voltage and current are sensed and compared against internal references or externally applied control levels so the supply provides either constant voltage or constant current regulation with automatic crossover depending on control level. Additional circuitry provides bias levels, circuit protection and metering functions.

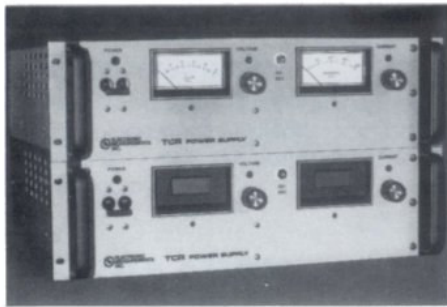

Front View: Units are available with analog or digital panel meters.

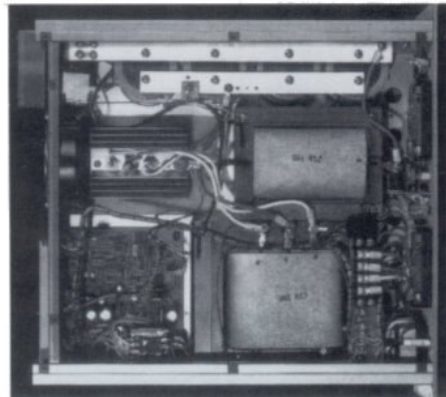

Top View: All control circuits, magnetic components, rectifiers and filter capacitors are accessible beneath top cover.

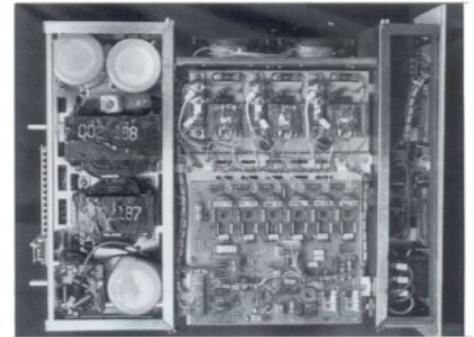

Circuit Card View: All bias, SCRs and control circuits on common assembly accessible beneath top cover.

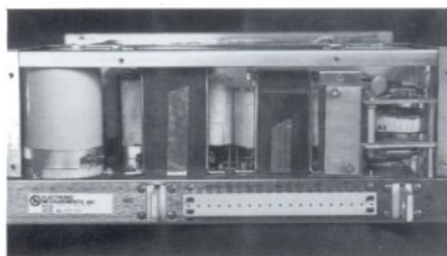

Rear View: Output terminals on rear surface. Also visible is double L/C filter and RFI filter section.

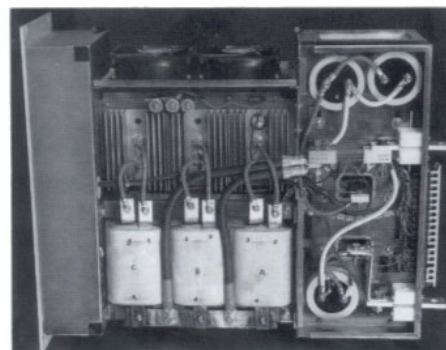

Bottom View: Fan cooling is carefully ducted through the unit to cool sensitive and heat-generating components such as rectifiers visible directly below the fans.



Rear View: Input, output, and programming terminals are covered for operator safety.

TCR Series Single-Phase

OPERATIONAL RATINGS

OUTPUT RATINGS @ 40°C		OUTPUT RIPPLE VOLTAGE @ FULL LOAD	PANEL SIZE (HEIGHT)	MODEL TCR-
VOLTAGE (V)	CURRENT (A)	Or Worst Case, Whichever Is Greater (RMS)	19" WIDTH 18" DEPTH	
0-7.5	0-70	80MV	3.5"	7.5S70
0-7.5	0-115	75MV	3.5"	7.5S115
0-7.5	0-200	80MV	5.25"	7.5S200
0-7.5	0-300	80MV	7"	7.5S300
0-10	0-50	80MV	3.5"	10S50
0-10	0-90	75MV	3.5"	10S90
0-10	0-165	80MV	5.25"	10S165
0-10	0-240	80MV	7"	10S240
0-20	0-30	80MV	3.5"	20S30
0-20	0-50	60MV	3.5"	20S50
0-20	0-90	80MV	5.25"	20S90
0-20	0-135	80MV	7"	20S135
0-40	0-15	100MV	3.5"	40S15
0-40	0-25	60MV	3.5"	40S25
0-40	0-45	100MV	5.25"	40S45
0-40	0-70	100MV	7"	40S70
0-60	0-10	120MV	3.5"	60S10
0-60	0-18	70MV	3.5"	60S18
0-60	0-30	90MV	5.25"	60S30
0-60	0-45	90MV	7"	60S45
0-80	0-8	150MV	3.5"	80S8
0-80	0-13	80MV	3.5"	80S13
0-80	0-23	120MV	5.25"	80S23
0-80	0-34	100MV	7"	80S34
0-150	0-4	300MV	3.5"	150S4
0-150	0-7	150MV	3.5"	150S7
0-150	0-12	200MV	5.25"	150S12
0-150	0-18	200MV	7"	150S18
0-300	0-2	500MV	3.5"	300S2
0-300	0-3	250MV	3.5"	300S3
0-300	0-6	300MV	5.25"	300S6
0-300	0-9	300MV	7"	300S9
0-600	0-1	1000MV	3.5"	600S1
0-600	0-1.6	700MV	3.5"	600S1.6
0-600	0-3	700MV	5.25"	600S3
0-600	0-4.5	750MV	7"	600S4.5

RFI CHARACTERISTICS (LINE CONDUCTED)

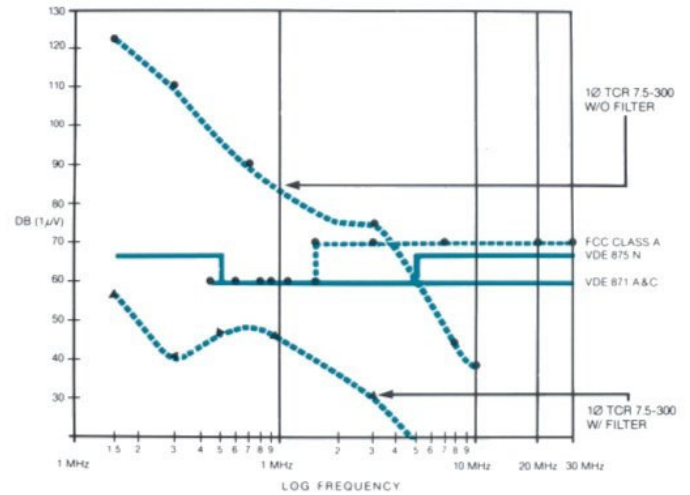

How to Order

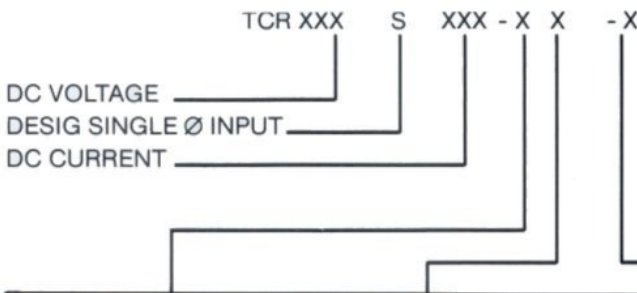

For example, consider Model TCR 20S50-2D-OV. This model provides 0 to 20 VOLTS output, 0 to 50 AMPS output, 220 V 1Ø input, digital panel meters and OVP add-on.

When ordering a particular model by this system it is urged that the required AC input be separately stated.

AC INPUT VOLTS		PANEL METER		FEATURES	
1	115 VAC 50-60Hz (N/A ON 2800W MODELS)	OMIT	ANALOG AM VM	OV	OVP ADD ON*
2	220 VAC 50-60Hz* (OPTIONAL STD., 7" UNITS)	D	DIGITAL AM VM	10T	10 TURN POT
				LB	LOCK BUSHINGS
3	100 VAC 50Hz*			TP	TEST POINTS
4	200 VAC 50Hz*			IL	INDUCTIVE LOAD
				RSTL	RSTL PROGRAMMER**

*Option available at extra charge

**INCREASES HEIGHT BY 1 3/4"

PROGRAMMING CHART	
TB101	FUNCTION
1	+ VOLTAGE
2	+ VOLTAGE SENSE REMOTE
3	V PROGRAMMING I
4	V AMP IN
5	V PROGRAMMING R
6	V PROGRAMMING R COM
7	-VOLTAGE SENSE REMOTE
8	-VOLTAGE
9	I PROGRAMMING I
10	I AMP IN
11	I PROGRAMMING R
12	-SHUNT
13	INVERTER AMP IN
14	+ SHUNT

SPECIFICATIONS

(RESISTIVE LOAD)

INPUT

STANDARD AC INPUT:

Standard AC input for 600, 1000 and 1800 watt models is 115 volts, 1 \emptyset , 47 to 63Hz. The supply will function within full specification from 105 to 130V. Current draw is 9.5A maximum for 600W units, 16A maximum for 1000W units, and 28A for 1800W units. Standard AC input for 2800 watt models is 208/220 VAC (190-253V) at a maximum current draw of 22 amps.

OPTIONAL AC INPUTS:

The 600, 1000 and 1800 watt models are available with optional AC inputs of 100V, 200V and 208/220 at extra cost. The 2800 watt models are available with optional AC input of 200V at extra cost.

AC INRUSH:

All models are "soft-started" so that on turn-on or during power interruption and reapplication, the input SCRs slowly phase-in from non-conduction to a conduction mode. There is no magnetic inrush current.

RFI/EMI:

Contains internal RFI filter employing ferrite toroidal chokes and "X" and "Y" VDE listed capacitors.

OUTPUT

OUTPUT RATINGS:

See rating table. Maximum voltage and current ratings for each model are available for operating ambient temperatures of 0° C to 40° C for output at 50° C. Derate 40° C current ratings by 10%.

REGULATION

LOAD EFFECTS:

Constant voltage mode — variations in output current from 5 to 100% of maximum rating cause output voltage variations of less than 0.1% of the output voltage setting when output is 50 to 100% of maximum rating. Below 50% output voltage, output variation will not exceed 0.05% of maximum output.

Constant current mode — variations of output voltage from 5 to 100% of maximum rating will result in output current variations of less than 0.1% of the output current setting when output is 50 to 100% of maximum rating. Below 50% output current, output variations will not exceed 0.05% of maximum output.

LINE EFFECTS:

When operating in either constant voltage or constant current mode, variations in the regulated output will not exceed 0.1% of 50 to 100% of output. Below 50% output variations will not exceed 0.05% of maximum rating.

RIPPLE:

Output voltage ripple shown in rating table is worst-case under any resistive load condition with the power line within specification. The highest ripple typically occurs at 50% output voltage and current and is lower as maximum output voltage and current is approached.

TRANSIENT RESPONSE:

A 30% step increase in power demanded by the load will cause a transient in the regulated output which will typically recover to within 2% of final value within 75ms.

STABILITY:

The stability of output voltage or current will remain within $\pm 0.05\%$ of set point for 8 hours after warm-up under fixed line, load and temperature conditions.

TEMPERATURE COEFFICIENT:

The temperature coefficient of the output voltage set point is 0.02%/° C of the maximum output voltage rating of the supply.

The temperature coefficient of the output current set point is 0.03%/° C of the maximum output current rating of the supply.

OPERATING TEMPERATURE:

All models operate within specification at continuous duty from 0° C to 40° C. Units may be safely stored at temperatures of -40° C to +85° C. Critical circuitry is thermostat-protected. Cooling is provided by a fan and air is ducted horizontally to prevent adjacent unit heating.

CONTROLS AND INSTRUMENTS:

All models provide AC turn on/off and circuit protection by means of a UL-rated input circuit breaker. Output control is provided by a 10-turn voltage control and a one-turn current control. Output indication is by voltage and current panel meters, available as analog or optionally available digital displays.

OVER VOLTAGE PROTECTION:

Optional over voltage protection (OVP) is available to protect the load from output over voltage above an adjustable set point of 50 to 110% of rated output. OVP action includes crowbar output, down program unit and open input circuit breaker.

PROGRAMMING:

The supply may be controlled locally or remotely. In the remote programming mode, externally provided resistance voltage or current will control the supply output. Programming sensitivity is 5000 OHMS, 5 volts or 1mA for full scale voltage output or 100 OHMS, 100mV or 1mA for full scale current output.

REMOTE SENSING:

Separate output sensing terminals are provided to sense remotely the output at a distant load. This feature compensates for the voltage drop in the power distribution system and provides specified regulation at the point of load.

PRODUCT CHANGES:

Product information published in this brochure was current at the time of printing. However, E/M reserves the right to change specifications, designs and models without prior notice.

TCR Series Three-Phase

OPERATIONAL RATINGS

OUTPUT RATINGS @ 50° C		OUTPUT RIPPLE VOLTAGE @ FULL LOAD	PANEL SIZE (HEIGHT)	MODEL TCR-
VOLTAGE (V)	CURRENT (A)	Or Worst Case, Whichever is Greater (RMS)	19" WIDTH 22" DEPTH	
0-7.5V	0-300A	30MV	7"	7.5T300
0-6V	0-600A	30MV	8.75"	6T600
0-6V	0-900A	30MV	12.25"	6T900
0-10V	0-250A	35MV	7"	10T250
0-10V	0-500A	35MV	8.75"	10T500
0-10V	0-750A	35MV	12.25"	10T750
0-20	0-125	20MV	7"	20T125
0-20	0-250	20MV	8.75"	20T250
0-20	0-500	20MV	12.25"	20T500
0-30	0-100	15MV	7"	30T100
0-30	0-200	15MV	8.75"	30T200
0-40	0-60	15MV	7"	40T60
0-40	0-125	15MV	8.75"	40T125
0-40	0-250	15MV	12.25"	40T250
0-50	0-200	18MV	12.25"	50T200
0-80	0-30	25MV	7"	80T30
0-80	0-60	25MV	8.75"	80T60
0-100	0-100	40MV	12.25"	100T100
0-120	0-20	40MV	7"	120T20
0-120	0-40	40MV	8.75"	120T40
0-160	0-15	60MV	7"	160T15
0-160	0-30	60MV	8.75"	160T30
0-160	0-60	60MV	12.25"	160T60
0-250	0-10	90MV	7"	250T10
0-250	0-20	90MV	8.75"	250T20
0-250	0-40	90MV	12.25"	250T40
0-500	0-5	125MV	7"	500T5
0-500	0-10	125MV	8.75"	500T10
0-500	0-20	125MV	12.25"	500T20

RFI CHARACTERISTICS (LINE CONDUCTED)

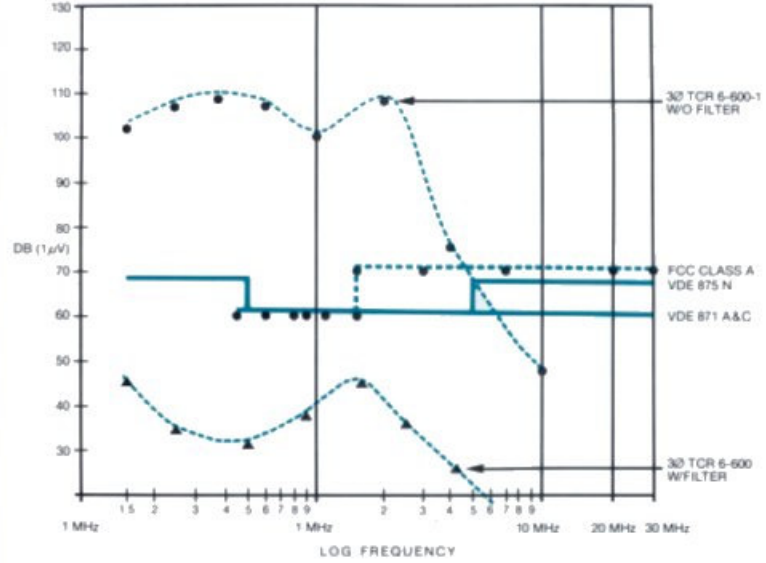

How to Order

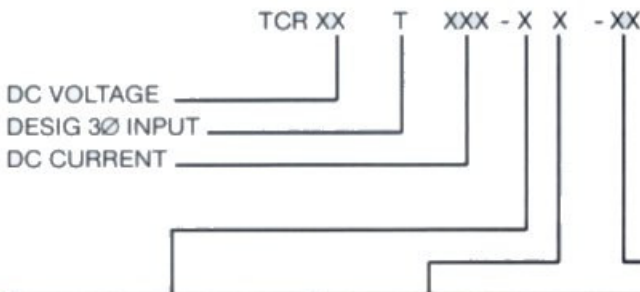

For example, consider Model TCR 7.5T300-4D-OV. This model provides 0 to 7.5 output voltage, 0 to 300 amps DC current, 440/460/480 VAC input, digital meter and OVP add-on. When specifying a particular model, always include information on AC input in addition to model number. This system was designed to help you specify the model best suited to your application.

	AC INPUT VOLTS	PANEL METER	FEATURES
1	208-220V 50-60HZ	OMIT	ANALOG AM/VM
2	380V 50HZ	D	DIGITAL AM/VM
3	415V50 HZ*		
4	440-460-480V* (414-505V)		
5	240V 60HZ*		
6	230V 50HZ*		
7	200V 50HZ*		

*Available at extra charge

**INCREASES HEIGHT BY 1 3/4"

TB2	FUNCTION
1	+ VOLTAGE
2	+ VOLTAGE SENSE REMOTE
3	V PROGRAMMING I
4	V AMP IN
5	V PROGRAMMING R
6	V PROGRAMMING R COM
7	- VOLTAGE SENSE REMOTE
8	- VOLTAGE
9	I PROGRAMMING I
10	I AMP IN
11	I PROGRAMMING R
12	- SHUNT
13	INVERTER AMP IN
14	+ SHUNT
15	6-32VDC OR 12-140 VAC IN
16	AC-DC OR SWITCH
17	SWITCH OR LINK TO 16

FACTORY WIRED FOR LOCAL TURN ON

SPECIFICATIONS

(RESISTIVE LOAD)

INPUT

STANDARD AC INPUT:

Standard AC input is 208/220/230 volts, 3 ϕ 47 to 63Hz. The supply will function within full specification from 190 to 253 volts. Phase-to-phase voltage balance requirements $\pm 2\%$ to achieve ripple specification. Larger deviations can be accommodated by recalibrating supply at installation. Phase rotation sequence of AC input is not required.

Current draw per phase: 2.5KW units 12 amps
5KW units 23 amps, 10KW units 46 amps at full load.

OPTIONAL AC INPUTS:

All models are available with optional AC inputs of 200V $\pm 10\%$, 380V $\pm 10\%$, 415V $\pm 10\%$ or 440/460/480V (414-505V) at extra cost.

AC INRUSH:

All models are "soft-started" so that on turn-on or during power interruption and reapplication, the input SCRs slowly phase-in from non-conduction to a conduction mode. There is no magnetic inrush current.

PHASE LOSS:

Loss of a phase voltage will inhibit power supply output and illuminate the front panel phase-loss light. No power supply damage will occur and when phase voltage is restored, normal operation will automatically resume.

REMOTE START/STOP/INTERLOCK:

The supply output can be remotely started or stopped by means of an external AC or DC voltage and/or external interlock closure. Unit will respond to 6 to 32 volts DC or 12 to 130 volts AC.

RFI/EMI:

Contains internal RFI filter employing ferrite toroidal chokes and "X" and "Y" VDE listed capacitors. (Capacitors in 480V models are non-VDE but are appropriately rated.)

OUTPUT

OUTPUT RATINGS:

See rating table. Maximum voltage and current ratings for each model are available for operating ambient temperatures of 0°C to +50°C.

REGULATION

LOAD EFFECTS:

Constant voltage mode — variations in output current from 5 to 100% of maximum rating cause output voltage variations of less than 0.1% of the output voltage setting when output is 50 to 100% of maximum rating. Below 50% output voltage, output variation will not exceed 0.05% of maximum output.

Constant current mode — variations of output voltage from 5 to 100% of maximum rating will result in output current variations of less than 0.1% of the output current setting when output is 50 to 100% of maximum rating. Below 50% output current, output variations will not exceed 0.05% of maximum output.

LINE EFFECTS:

When operating in either constant voltage or constant current mode, variations in the regulated output will not exceed 0.1% of 50 to 100% of output. Below 50% output variations will not exceed 0.05% of maximum rating.

RIPPLE:

Output voltage ripple shown in rating table is worst-case under any resistive load condition with the power line within specification. The highest ripple typically occurs at 50% output voltage and current and is lower as maximum output voltage and current is approached.

TRANSIENT RESPONSE:

A 30% step increase in power demanded by the load will cause a transient in the regulated output which will typically recover to within 2% of final value within 75ms.

STABILITY:

The stability of output voltage or current will remain within $\pm 0.05\%$ of set point for 8 hours after warm-up under fixed line, load and temperature conditions.

TEMPERATURE COEFFICIENT:

The temperature coefficient of the output voltage set point is 0.02%/°C of the maximum output voltage rating of the supply. The temperature coefficient of the output current set point is 0.03%/°C of the maximum output current rating of the supply.

OPERATING TEMPERATURE:

All models operate within specification at continuous duty from 0°C to +50°C. Units may be safely stored at temperatures of -40°C to +85°C. Critical circuitry is thermostat-protected. Cooling is provided by fans and air is ducted horizontally to prevent adjacent unit heating.

CONTROLS AND INSTRUMENTS:

All models provide AC turn on/off and circuit protection by means of a UL-rated three-pole input circuit breaker. Output control is provided by a 10-turn voltage control and a one-turn current control. Output indication is by voltage and current panel meters, available as analog or optionally available digital displays.

OVER VOLTAGE PROTECTION:

Optional over voltage protection (OVP) is available to protect the load from output over voltage above an adjustable set point of 50 to 110% of rated output. OVP action includes crowbar output, down program unit and open input circuit breaker.

PROGRAMMING:

The supply may be controlled locally or remotely. In the remote programming mode, externally provided resistance voltage or current will control the supply output. Programming sensitivity is 5000 OHMS, 5 volts or 1mA for full scale voltage output or 100 OHMS, 100mV or 1mA for full scale current output.

REMOTE SENSING:

Separate output sensing terminals are provided to sense remotely the output at a distant load. This feature compensates for the voltage drop in the power distribution system and provides specified regulation at the point of load.

PRODUCT CHANGES - product information published in this brochure was current at time of printing, however, E/M reserves the right to change specifications, designs and models without prior notice.

TCR Series Single-Phase Power Supplies

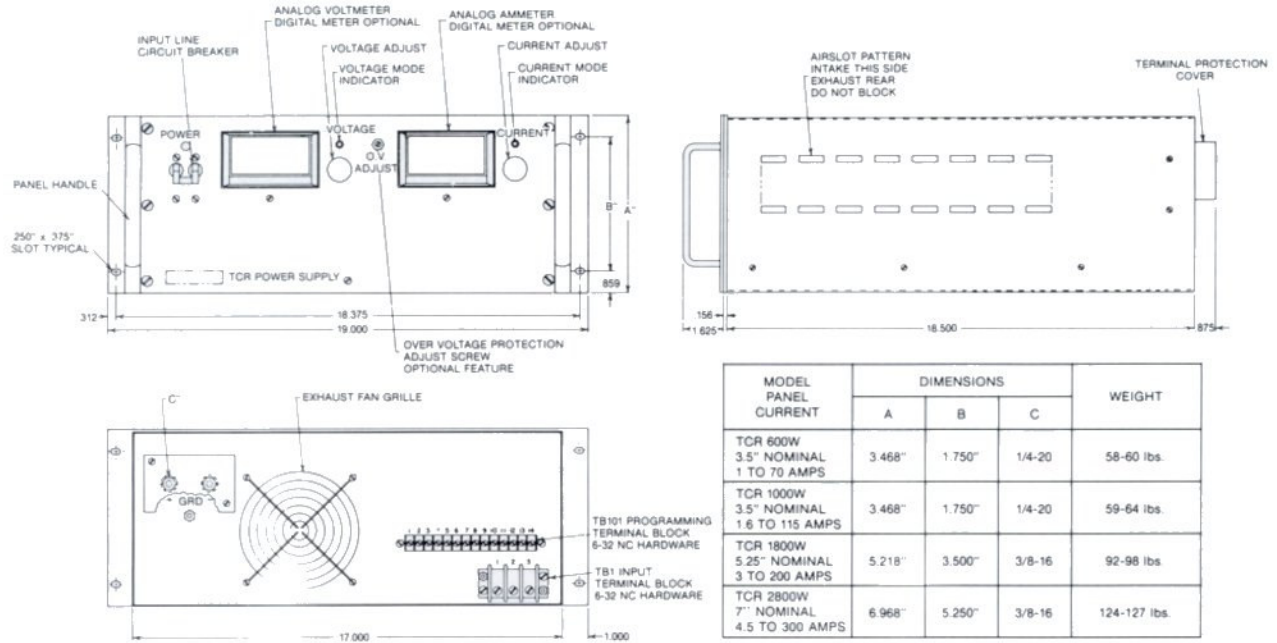

TCR Series Three-Phase Power Supplies

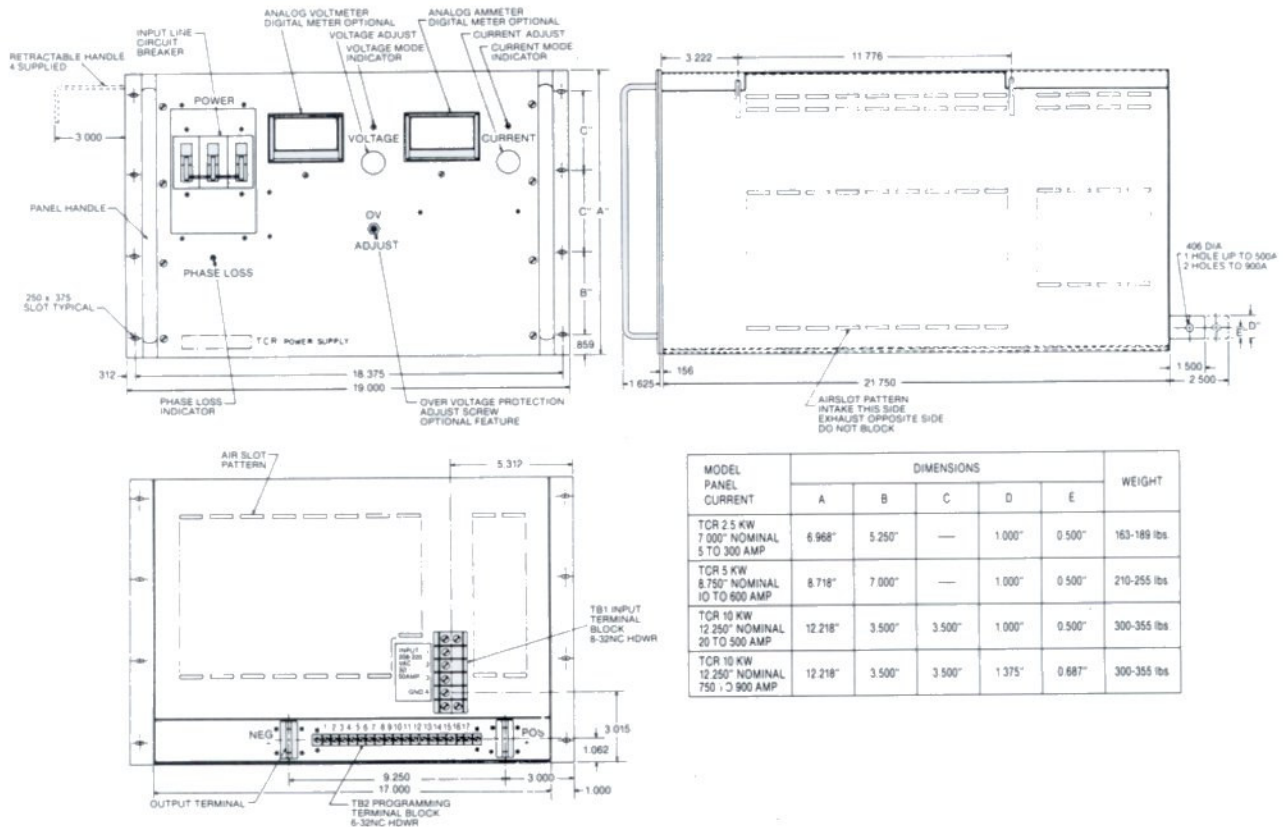

**ELECTRONIC
MEASUREMENTS
INC.**

Call 732-922-9300
Fax 732-922-9334

405 ESSEX ROAD, NEPTUNE, NJ 07753
"Specialists In Power Conversion"

Printed in U.S.A.
03-100-04 REV. 1